

# Copa de Espana A Don Benito 2023

Don Benito (ESP), 13 May 2023

## -50 kg

21 Judoka

POOL A

|    |                                   |     |    |                           |
|----|-----------------------------------|-----|----|---------------------------|
| 1  | OLMO ESTEVEZ , Javier             | EXT | 1  | OLMO ESTEVEZ , J. (EXT)   |
| 17 |                                   |     | 17 |                           |
| 9  | MARTINEZ REBOLO , Adrian          | EXT | 2  |                           |
| 25 | BARBEITO SANJURJO, Martin Alberto | GAL | 25 |                           |
| 5  | HERNANDEZ SOLIS, Daniel           | EXT | 3  | HERNANDEZ SOLIS, D. (EXT) |
| 21 |                                   |     | 18 |                           |
| 13 |                                   |     | 4  | CRISTOBAL SAENZ E. (AND)  |
| 29 | CRISTOBAL SAENZ, Eneko            | AND | 29 |                           |

POOL A Winner / Ganador  
Vainqueur / Sieger

POOL B

|    |                               |     |    |                        |
|----|-------------------------------|-----|----|------------------------|
| 3  |                               |     | 5  | PRIETO MUNOZ, A. (EXT) |
| 19 | PRIETO MUNOZ, Alex            | EXT | 19 |                        |
| 11 | CARRETERO GIRALDO, Aurelio    | EXT | 6  |                        |
| 27 | YAGUE LANCHAS, Marcos         | MAD | 27 |                        |
| 7  | GONCZAROWSKA MACHADO, Andreia | POR | 7  |                        |
| 23 | COLON FIGUEROA, Jose Atonio   | EXT | 23 |                        |
| 15 |                               |     | 8  | CAMPOS RUBIO, J. (CLE) |
| 31 | CAMPOS RUBIO, Javier          | CLE | 31 |                        |

POOL B Winner / Ganador  
Vainqueur / Sieger

POOL C

|    |                                |     |    |                             |
|----|--------------------------------|-----|----|-----------------------------|
| 2  |                                |     | 9  | RIGOTE RODRIGUEZ , E. (EXT) |
| 18 | RIGOTE RODRIGUEZ , Eusebio     | EXT | 18 |                             |
| 10 |                                |     | 10 | RAMOS MESA, Yuan (CAN)      |
| 26 | RAMOS MESA, Yuan               | CAN | 26 |                             |
| 6  | MARTIN VAZQUEZ, Juan Francisco | EXT | 11 |                             |
| 22 | FLUERICA , Madalin             | ARA | 22 |                             |
| 14 | RONCERO BARRENA, Rodrigo       | MAD | 14 | RONCERO BARRENA, R. (MAD)   |
| 30 |                                |     | 30 |                             |

POOL C Winner / Ganador  
Vainqueur / Sieger

POOL D

|    |                                |     |    |                             |
|----|--------------------------------|-----|----|-----------------------------|
| 4  | HERNANDEZ MADRUGA, Raul        | EXT | 13 | HERNANDEZ MADRUGA, R. (EXT) |
| 20 |                                |     | 20 |                             |
| 12 | PIRES GAISITA, Tomas Alexandre | POR | 12 | PIRES GAISITA, T. (POR)     |
| 28 |                                |     | 28 |                             |
| 8  | GONZALEZ BANON, Angel          | EXT | 15 | GONZALEZ BANON, A. (EXT)    |
| 24 |                                |     | 24 |                             |
| 16 | BIOSCA GARCIA, Renat           | VAL | 16 |                             |
| 32 | GRAGERA GONZALEZ, Andrei       | EXT | 32 |                             |

POOL D Winner / Ganador  
Vainqueur / Sieger

Trostrunde / Repechage / Ronda de consolación

Repechage / Trostrunde / Repeche

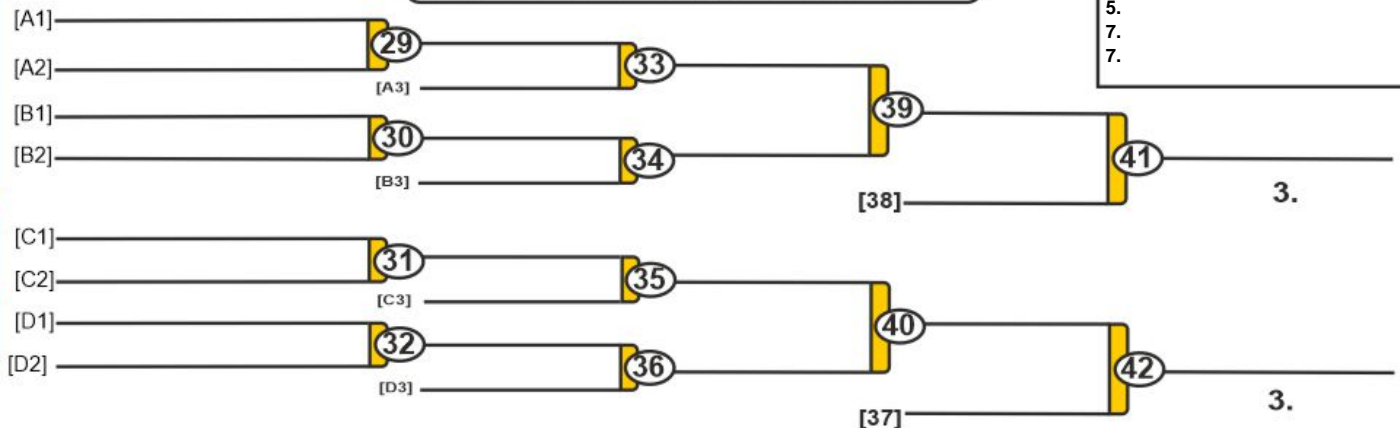

| Results                               |  |
|---------------------------------------|--|
| Résultat / Platzierungen / Resultados |  |
| 1.                                    |  |
| 2.                                    |  |
| 3.                                    |  |
| 3.                                    |  |
| 5.                                    |  |
| 5.                                    |  |
| 7.                                    |  |
| 7.                                    |  |

# Copa de Espana A Don Benito 2023

Don Benito (ESP), 13 May 2023

## -55 kg

32 Judoka

POOL A

|    |                             |     |    |
|----|-----------------------------|-----|----|
| 1  | NAVARRO ALCON, Juan Antonio | CAN | 1  |
| 17 | LAGO PEREZ, Pancho          | GAL | 17 |
| 9  | ESTEVEZ, Andre              | POR | 2  |
| 25 | MIGUELEZ BRACCO, Lucas      | MAD | 25 |
| 5  | MARTIN TORRES, Carlos       | ARA | 3  |
| 21 | VARGAS MONTES, Gabriel      | EXT | 18 |
| 13 | LEAL RODRIGUEZ, Oscar       | VAL | 4  |
| 29 | CAETANO, Diogo              | POR | 18 |

POOL B

|    |                                   |     |    |
|----|-----------------------------------|-----|----|
| 3  | ROMERO GONZALEZ, Fernando         | EXT | 5  |
| 19 | PALMA, Tomas                      | POR | 19 |
| 11 | PENA GARCIA, Ivan                 | RIO | 6  |
| 27 | FRAILE DOMINGUEZ, Raul            | MAD | 26 |
| 7  | SANTOS, Daniel                    | POR | 7  |
| 23 | VAZQUEZ AGUDO, Carlos             | EXT | 20 |
| 15 | VICENS RODRIGUEZ DE LIEBANA, Yvan | ARA | 8  |
| 31 | PLAZA POLO, Hugo                  | GAL | 20 |

POOL C

|    |                               |     |    |
|----|-------------------------------|-----|----|
| 2  | MENDOZA MARRERO, Andrew       | CAN | 9  |
| 18 | GOMES, David                  | POR | 21 |
| 10 | CHACON RASTROJO, Mario        | EXT | 10 |
| 26 | PINTO NEVA, Jaime             | AND | 27 |
| 6  | VAZ, Rodrigo                  | POR | 11 |
| 22 | MADRIGAL RAMIRO, Jose Antonio | EXT | 22 |
| 14 | RICO PEDRIDO, Pablo           | GAL | 12 |
| 30 | BONILLO OUDDAI, Amir          | VAL | 22 |

POOL D

|    |                           |     |    |
|----|---------------------------|-----|----|
| 4  | AZERA, Rodrigo            | POR | 13 |
| 20 | SANCHEZ MATEOS, Ismael    | EXT | 23 |
| 12 | CASTRO LOPEZ, Esteban     | GAL | 14 |
| 28 | CERQUEIRA, Filipe         | POR | 28 |
| 8  | PAJARES DOMINGUEZ, Jose   | MAD | 15 |
| 24 | PALOMINO HERNANDEZ, Aaron | EXT | 24 |
| 16 | FERNANDEZ FERNANDEZ, Iker | GAL | 16 |
| 32 | MESQUITA, Nuno            | POR | 24 |

Trostrunde / Repechage / Ronda de consolación

Repechage / Trostrunde / Repechage

|      |    |    |
|------|----|----|
| [A1] | 29 | 33 |
| [A2] |    |    |
| [B1] | 30 | 34 |
| [B2] |    |    |
| [C1] | 31 | 35 |
| [C2] |    |    |
| [D1] | 32 | 36 |
| [D2] |    |    |

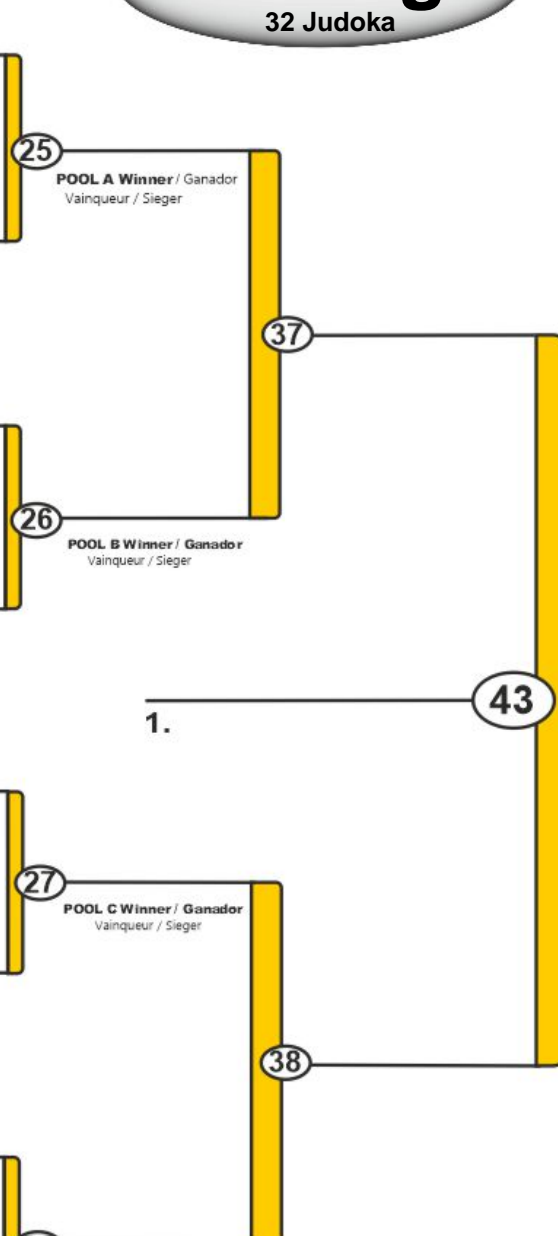

| Results                               |  |
|---------------------------------------|--|
| Résultat / Platzierungen / Resultados |  |
| 1.                                    |  |
| 2.                                    |  |
| 3.                                    |  |
| 5.                                    |  |
| 5.                                    |  |
| 7.                                    |  |
| 7.                                    |  |

# Copa de Espana A Don Benito 2023

Don Benito (ESP), 13 May 2023

## -60 kg

40 Judoka

POOL A

|    |                                 |    |
|----|---------------------------------|----|
| 1  | GARCIA ZAMORA, Ivo              | 33 |
| 33 | GARCIA ZAMORA, Ivo              | 33 |
| 17 | FERNANDEZ-GAYTAN VAZQUEZ, Jorge | 34 |
| 49 | GOMEZ ABELLAN, Hector           | 49 |
| 9  | SANTOS, Dinis                   | 3  |
| 41 | SANTOS, Dinis                   | 3  |
| 25 | VALADES GIL, Hector             | 4  |
| 57 | VALADES GIL, Hector             | 4  |
| 5  | VILLALOBOS PEREZ, Pablo         | 5  |
| 37 | VILLALOBOS PEREZ, Pablo         | 5  |
| 21 | SERENO, Jose                    | 6  |
| 53 | VILA FERREIRO, Eduardo          | 6  |
| 13 | CARDIL BONSON, Hector           | 7  |
| 45 | CARDIL BONSON, Hector           | 7  |
| 29 | GOMEZ BOLARIN, Gabriel          | 8  |
| 61 | GOMEZ BOLARIN, Gabriel          | 8  |

POOL B

|    |                            |    |
|----|----------------------------|----|
| 3  | HERNANDEZ CHALARCA, Samuel | 9  |
| 35 | LESTON GARCIA, Ricardo     | 9  |
| 19 | FERREIRA, Tiago            | 10 |
| 51 | FERREIRA, Tiago            | 10 |
| 11 | FARFAN SANCHEZ, Efre       | 11 |
| 43 | FARFAN SANCHEZ, Efre       | 11 |
| 27 | SANCHEZ COSTA, Mario       | 12 |
| 59 | SANCHEZ COSTA, Mario       | 12 |
| 7  | TEJEIRO BORREGUERO, Marcos | 13 |
| 39 | TEJEIRO BORREGUERO, Marcos | 13 |
| 23 | VIDAL NAVARRO, Hector      | 14 |
| 55 | VIDAL NAVARRO, Hector      | 14 |
| 15 | PEREZ CAVERO, Adrian       | 15 |
| 47 | GONZAROWSKA, Joao Vitor    | 15 |
| 31 | DORADO DEL VIEJO, Alvaro   | 16 |
| 63 | DORADO DEL VIEJO, Alvaro   | 16 |

POOL C

|    |                            |    |
|----|----------------------------|----|
| 2  | TEJEIRO BORREGUERO, Alvaro | 17 |
| 34 | GARCIA RODRIGUEZ, Abel     | 17 |
| 18 | GARCIA VELASCO, Pablo      | 18 |
| 50 | GARCIA VELASCO, Pablo      | 18 |
| 10 | SHESTAKOV, Yaroslav        | 19 |
| 42 | SHESTAKOV, Yaroslav        | 19 |
| 26 | VAZ, Pedro                 | 20 |
| 58 | VAZ, Pedro                 | 20 |
| 6  | ALVAREZ SHUTOV, Daniel     | 21 |
| 38 | ALVAREZ SHUTOV, Daniel     | 21 |
| 22 | FERNANDES, Vicente         | 22 |
| 54 | FERNANDES, Vicente         | 22 |
| 14 | ANDRES FERNANDEZ, Edgar    | 23 |
| 46 | ANDRES FERNANDEZ, Edgar    | 23 |
| 30 | GREGORI CASTRO, David      | 24 |
| 62 | GREGORI CASTRO, David      | 24 |

POOL D

|    |                                   |    |
|----|-----------------------------------|----|
| 4  | CANOVAS LOPEZ, Aram               | 25 |
| 36 | CANOVAS LOPEZ, Aram               | 25 |
| 20 | PACHECO HERNANDEZ-MONTANO, Javier | 26 |
| 52 | PACHECO HERNANDEZ-MONTANO, Javier | 26 |
| 12 | BARRERO CALDERON, Gabriel         | 27 |
| 44 | TEIXEIRA, Goncalo                 | 27 |
| 28 | NAVARRETE GEA, Alejandro          | 28 |
| 60 | NAVARRETE GEA, Alejandro          | 28 |
| 8  | SIEIRO VAZQUEZ, Pablo             | 29 |
| 40 | SIEIRO VAZQUEZ, Pablo             | 29 |
| 24 | MANSO FERNANDEZ, Oscar            | 30 |
| 56 | MANSO FERNANDEZ, Oscar            | 30 |
| 16 | FLUERICA, Emanuel                 | 31 |
| 48 | SANCHEZ MARTINEZ, Hector          | 31 |
| 32 | RIJO, Guilherme                   | 32 |
| 64 | RIJO, Guilherme                   | 32 |

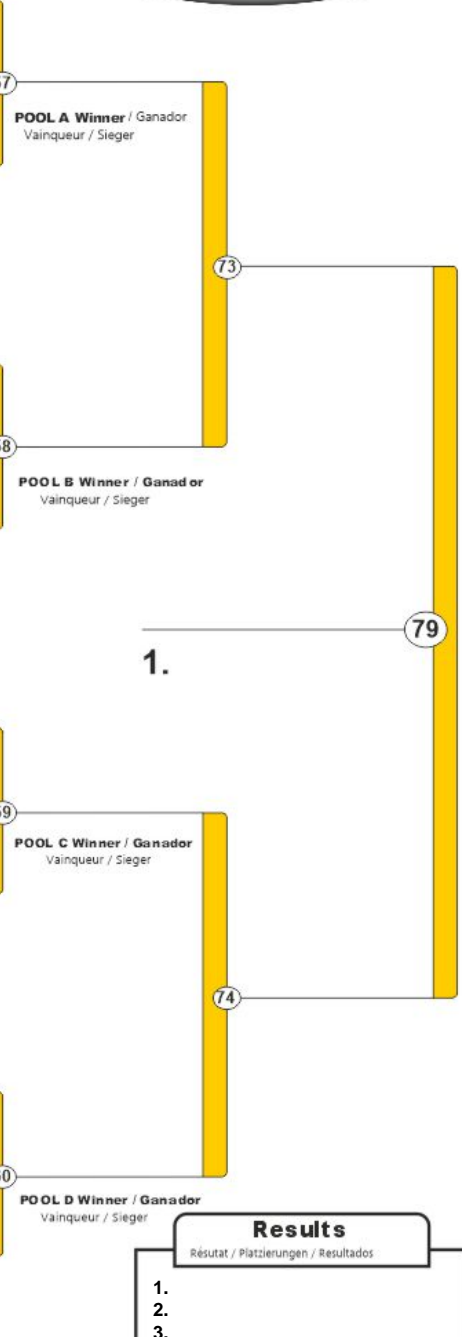

1.

| Results                               |  |
|---------------------------------------|--|
| Resultat / Platzierungen / Resultados |  |
| 1.                                    |  |
| 2.                                    |  |
| 3.                                    |  |
| 4.                                    |  |
| 5.                                    |  |
| 6.                                    |  |
| 7.                                    |  |

Trostrunde / Repechage / Ronda de consolación

Repechage / Trostrunde / Repecha

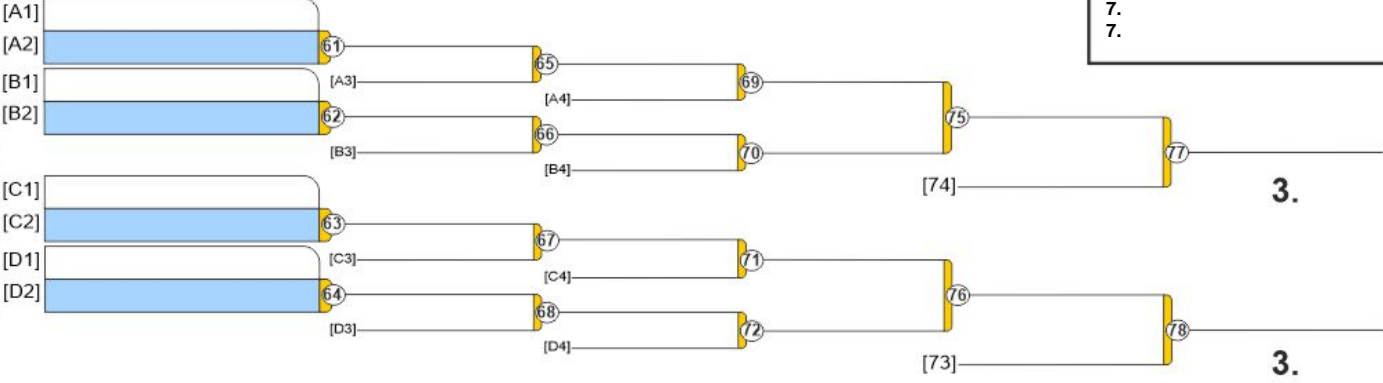

# Copa de Espana A Don Benito 2023

Don Benito (ESP), 13 May 2023

## -66 kg

30 Judoka

POOL A

|    |                          |     |    |
|----|--------------------------|-----|----|
| 1  | DRZYZGA, Javier Rafael   | MAD | 1  |
| 17 | GODINHO, Francisco       | POR | 17 |
| 9  | BOTANA LOPEZ, Carlos     | GAL | 2  |
| 25 | MARTIN RAMOS, Miguel     | EXT | 25 |
| 5  | CABRAL, Francisco        | POR | 3  |
| 21 | GRACIA SANCHEZ, Leo      | ARA | 18 |
| 13 | TREJO QUINTANA, Marcos   | EXT | 4  |
| 29 | TREJO QUINTANA, M. (EXT) |     | 4  |

POOL A Winner / Ganador  
Vainqueur / Sieger

POOL B

|    |                                |     |    |
|----|--------------------------------|-----|----|
| 3  | DIAZ CAZORLA, Oscar            | CLM | 5  |
| 19 | PINTO, Daniel                  | POR | 19 |
| 11 | PONTE BARCA, Raul              | GAL | 6  |
| 27 | GARCIA ESCALERA, Jorge         | MAD | 20 |
| 7  | RODRIGUEZ YANEZ, Adriel        | CAN | 7  |
| 23 | SANTOS, Francisco              | POR | 20 |
| 15 | VALDIVIESO MARTIN, Jose Miguel | EXT | 8  |
| 31 | ROCHA MIRANDA, Mateo           | GAL | 8  |

POOL B Winner / Ganador  
Vainqueur / Sieger

POOL C

|    |                           |     |    |
|----|---------------------------|-----|----|
| 2  | CAMPOS CORREA, Dorian     | MAD | 9  |
| 18 | LOPEZ SANMARTIN, Pablo    | GAL | 21 |
| 10 | CASTRO MARTINEZ, Dayron   | EXT | 10 |
| 26 | PAVAO, Joao               | POR | 22 |
| 6  | VILA, Duarte              | POR | 11 |
| 22 | CASTEDO TRASHORRAS, Cesar | GAL | 22 |
| 14 | PIZARRO CASAS, Ivan       | MAD | 12 |
| 30 | IGLESIAS ISTRATE, Ricardo | CLM | 12 |

POOL C Winner / Ganador  
Vainqueur / Sieger

POOL D

|    |                             |     |    |
|----|-----------------------------|-----|----|
| 4  | MERA CARMONA, Aaron         | EXT | 13 |
| 20 | SOARES, Isac                | POR | 23 |
| 12 | SALGADO ROS, Diego          | MAD | 14 |
| 28 | PLA ZANUY, Sandro           | ARA | 24 |
| 8  | LOURO SANCHEZ, Matias       | GAL | 15 |
| 24 | PULGARIN GALACHE, Alejandro | EXT | 24 |
| 16 | SOUSA, Simao                | POR | 16 |
| 32 | SOUSA, Simao (POR)          |     | 16 |

POOL D Winner / Ganador  
Vainqueur / Sieger

1.

43

| Results                               |  |
|---------------------------------------|--|
| Résultat / Platzierungen / Resultados |  |
| 1.                                    |  |
| 2.                                    |  |
| 3.                                    |  |
| 5.                                    |  |
| 5.                                    |  |
| 7.                                    |  |
| 7.                                    |  |

Trostrunde / Repechage / Ronda de consolación

Repechage / Trostrunde / Repechage

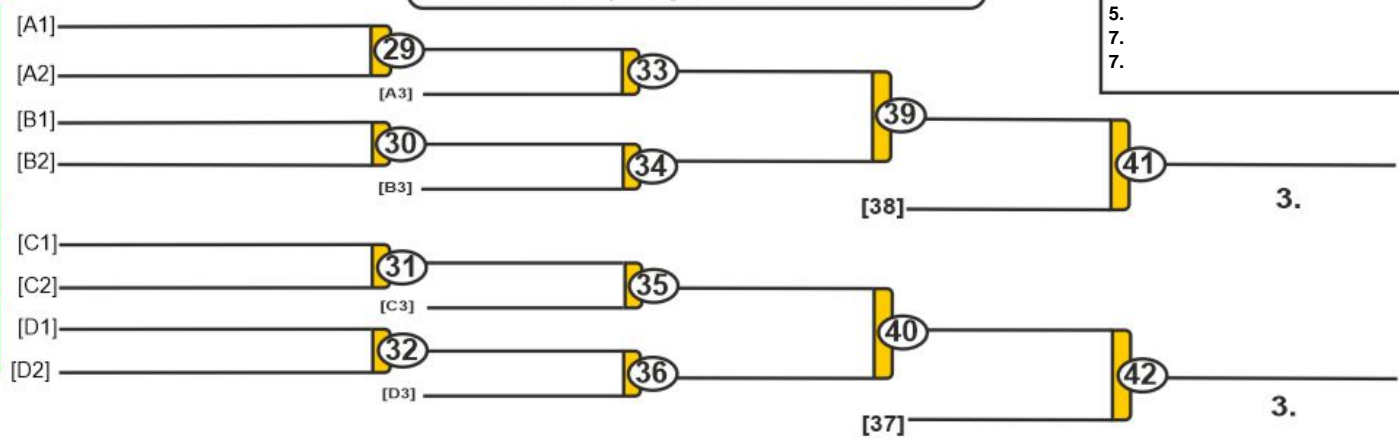

3.

3.

# Copa de Espana A Don Benito 2023

Don Benito (ESP), 13 May 2023

## -73 kg

21 Judoka

POOL A

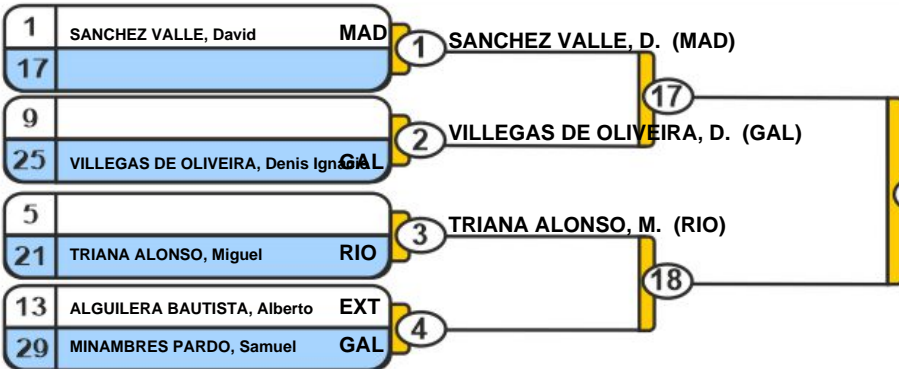

POOL A Winner / Ganador  
Vainqueur / Sieger

POOL B

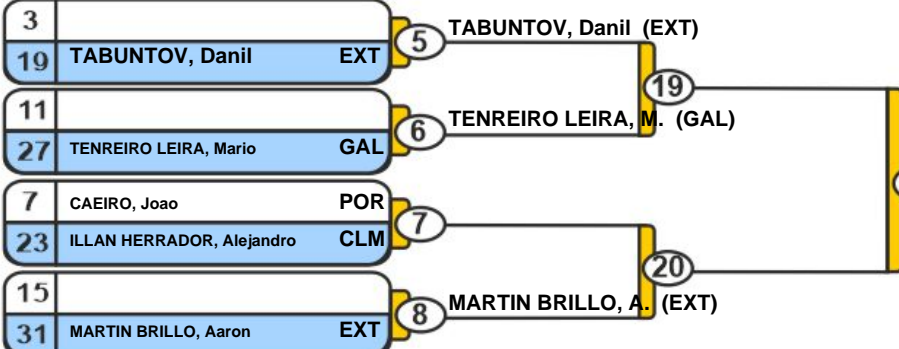

POOL B Winner / Ganador  
Vainqueur / Sieger

POOL C

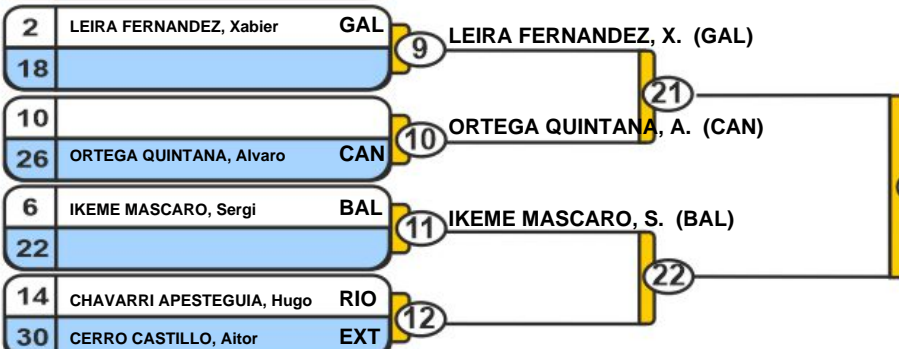

POOL C Winner / Ganador  
Vainqueur / Sieger

POOL D



POOL D Winner / Ganador  
Vainqueur / Sieger

Trostrunde / Repechage / Ronda de consolación

Repechage / Trostrunde / Repeche

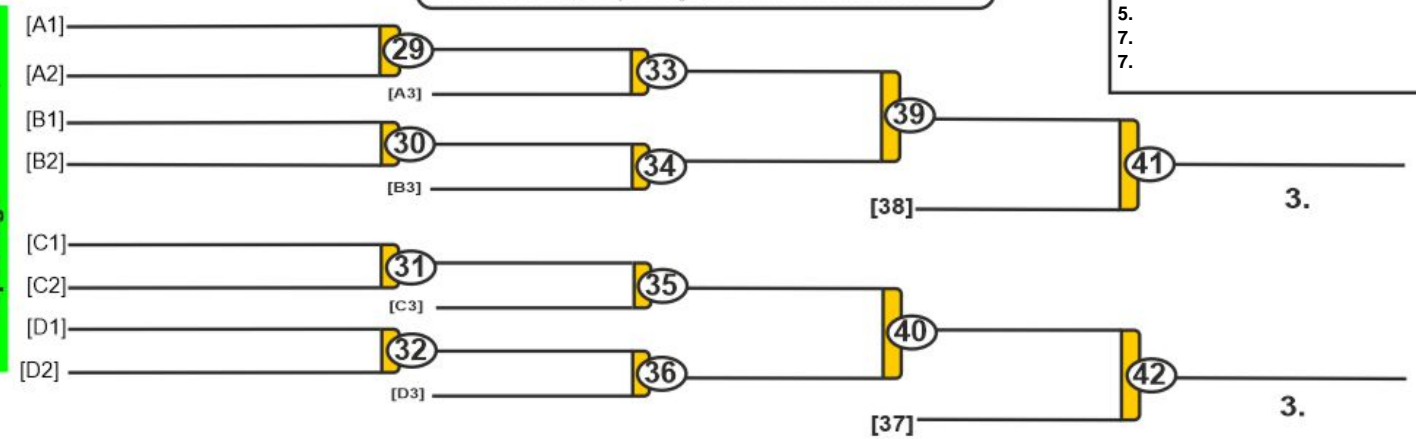

| Results                               |  |
|---------------------------------------|--|
| Résultat / Platzierungen / Resultados |  |
| 1.                                    |  |
| 2.                                    |  |
| 3.                                    |  |
| 3.                                    |  |
| 5.                                    |  |
| 5.                                    |  |
| 7.                                    |  |
| 7.                                    |  |

# Copa de Espana A Don Benito 2023

Don Benito (ESP), 13 May 2023

## -81 kg

11 Judoka

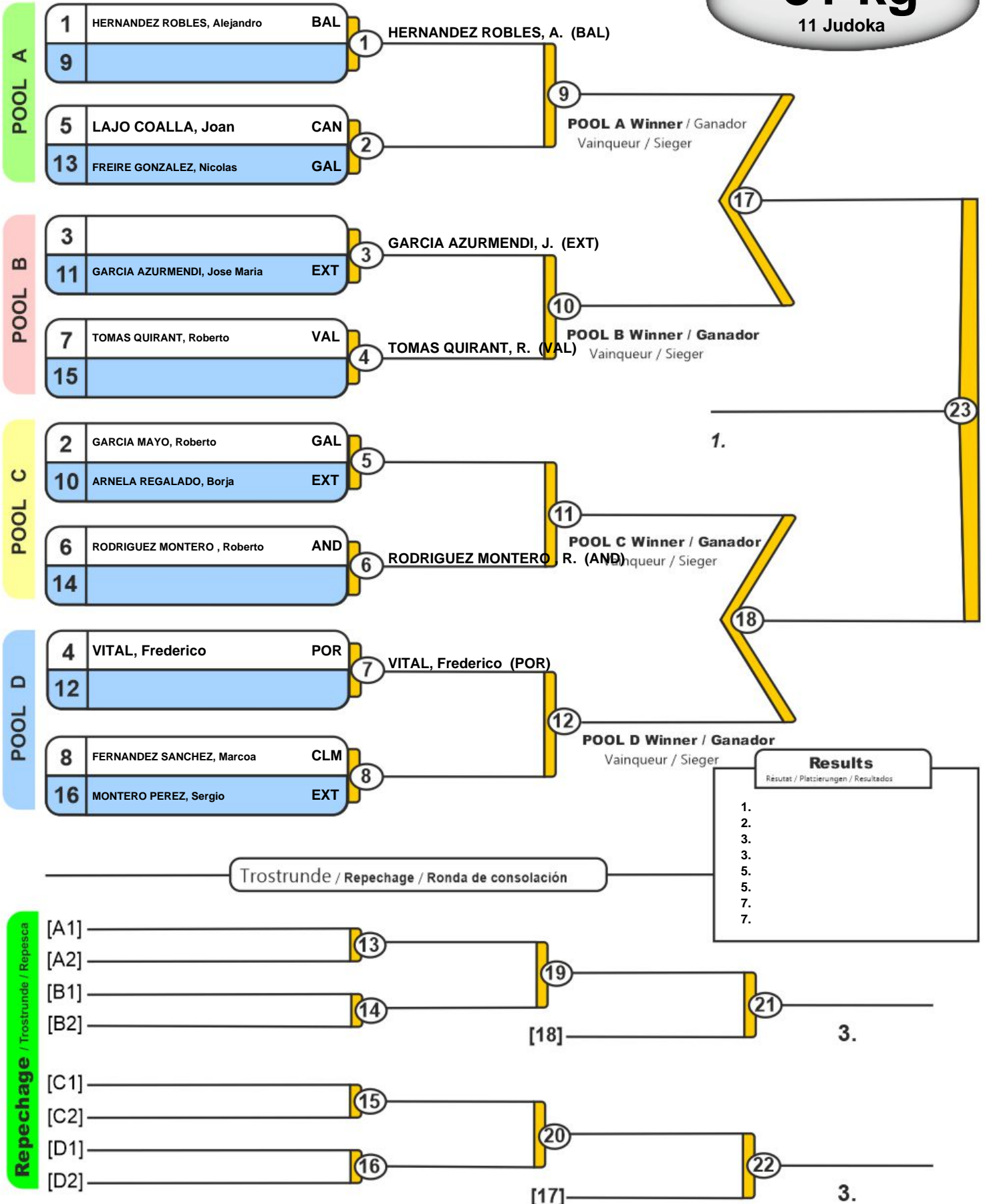

# Copa de España A Don Benito 2023

Don Benito (ESP), 13 May 2023

## -90 kg

6 Judoka

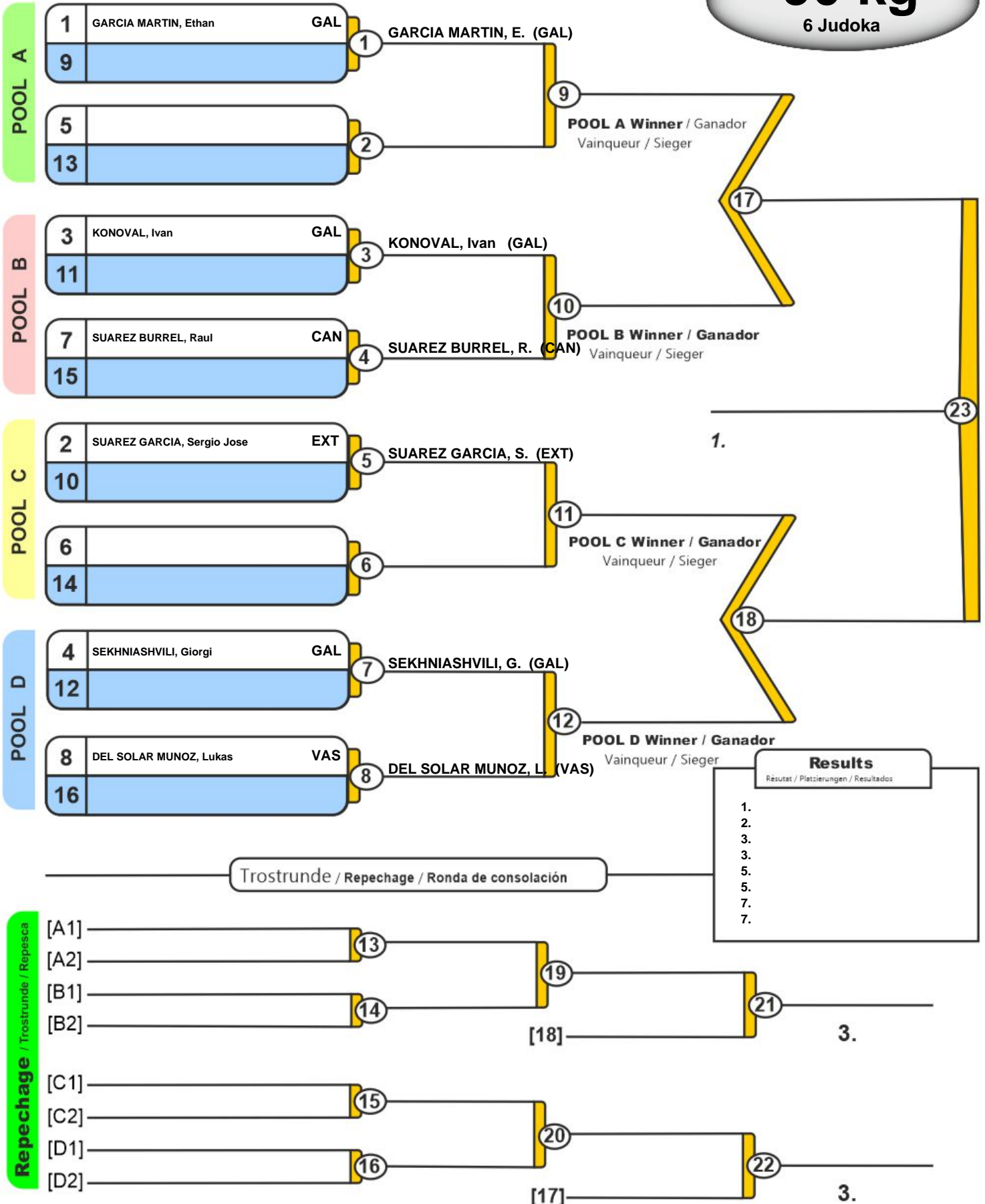



# Copa de Espana A Don Benito 2023

Don Benito (ESP), 13 May 2023

## +90 kg

5 Judoka

|   |                           |     | 1 | 2 | 3 | 4 | 5 |     |
|---|---------------------------|-----|---|---|---|---|---|-----|
| 1 | LOPEZ REYES, Adrian       | EXT |   |   |   |   |   | (0) |
| 2 | ROSARIO REYES, Antonio    | EXT |   |   |   |   |   | (0) |
| 3 | HERENCIA SOSA, Joao Pedro | EXT |   |   |   |   |   | (0) |
| 4 | NETO, Francisco           | POR |   |   |   |   |   | (0) |
| 5 | BELLO DEVESA, Mateo       | GAL |   |   |   |   |   | (0) |

|   |                        |     |   |
|---|------------------------|-----|---|
| 1 | LOPEZ REYES, Adrian    | EXT | 1 |
| 2 | ROSARIO REYES, Antonio | EXT |   |

|   |                           |     |   |
|---|---------------------------|-----|---|
| 3 | HERENCIA SOSA, Joao Pedro | EXT | 2 |
| 4 | NETO, Francisco           | POR |   |

|   |                     |     |   |
|---|---------------------|-----|---|
| 1 | LOPEZ REYES, Adrian | EXT | 3 |
| 5 | BELLO DEVESA, Mateo | GAL |   |

|   |                           |     |   |
|---|---------------------------|-----|---|
| 2 | ROSARIO REYES, Antonio    | EXT | 4 |
| 3 | HERENCIA SOSA, Joao Pedro | EXT |   |

|   |                     |     |   |
|---|---------------------|-----|---|
| 4 | NETO, Francisco     | POR | 5 |
| 5 | BELLO DEVESA, Mateo | GAL |   |

|   |                           |     |   |
|---|---------------------------|-----|---|
| 1 | LOPEZ REYES, Adrian       | EXT | 6 |
| 3 | HERENCIA SOSA, Joao Pedro | EXT |   |

|   |                        |     |   |
|---|------------------------|-----|---|
| 2 | ROSARIO REYES, Antonio | EXT | 7 |
| 4 | NETO, Francisco        | POR |   |

|   |                           |     |   |
|---|---------------------------|-----|---|
| 3 | HERENCIA SOSA, Joao Pedro | EXT | 8 |
| 5 | BELLO DEVESA, Mateo       | GAL |   |

|   |                     |     |   |
|---|---------------------|-----|---|
| 1 | LOPEZ REYES, Adrian | EXT | 9 |
| 4 | NETO, Francisco     | POR |   |

|   |                        |     |    |
|---|------------------------|-----|----|
| 2 | ROSARIO REYES, Antonio | EXT | 10 |
| 5 | BELLO DEVESA, Mateo    | GAL |    |

### Final Results

- 1.
- 2.
- 3.





# Copa de Espana A Don Benito 2023

Don Benito (ESP), 13 May 2023

# -40 kg

3 Judoka

|   |                            |     | 1 | 2 | 3 | Wins<br>Score |
|---|----------------------------|-----|---|---|---|---------------|
| 1 | RIVERA FERNANDEZ, Sara Mai | GAL |   |   |   | 0<br>0        |
| 2 | DIAZ FERNANDEZ, Yanira     | AND |   |   |   | 0<br>0        |
| 3 | REMIGIO RUIZ , Nadia       | EXT |   |   |   | 0<br>0        |

|   |                            |     |   |
|---|----------------------------|-----|---|
| 1 | RIVERA FERNANDEZ, Sara Mai | GAL | ① |
| 2 | DIAZ FERNANDEZ, Yanira     | AND |   |

|   |                            |     |   |
|---|----------------------------|-----|---|
| 1 | RIVERA FERNANDEZ, Sara Mai | GAL | ② |
| 3 | REMIGIO RUIZ , Nadia       | EXT |   |

|   |                        |     |   |
|---|------------------------|-----|---|
| 2 | DIAZ FERNANDEZ, Yanira | AND | ③ |
| 3 | REMIGIO RUIZ , Nadia   | EXT |   |

## Final Results

- 1.
- 2.
- 3.

# Copa de España A Don Benito 2023

Don Benito (ESP), 13 May 2023

## -44 kg

10 Judoka

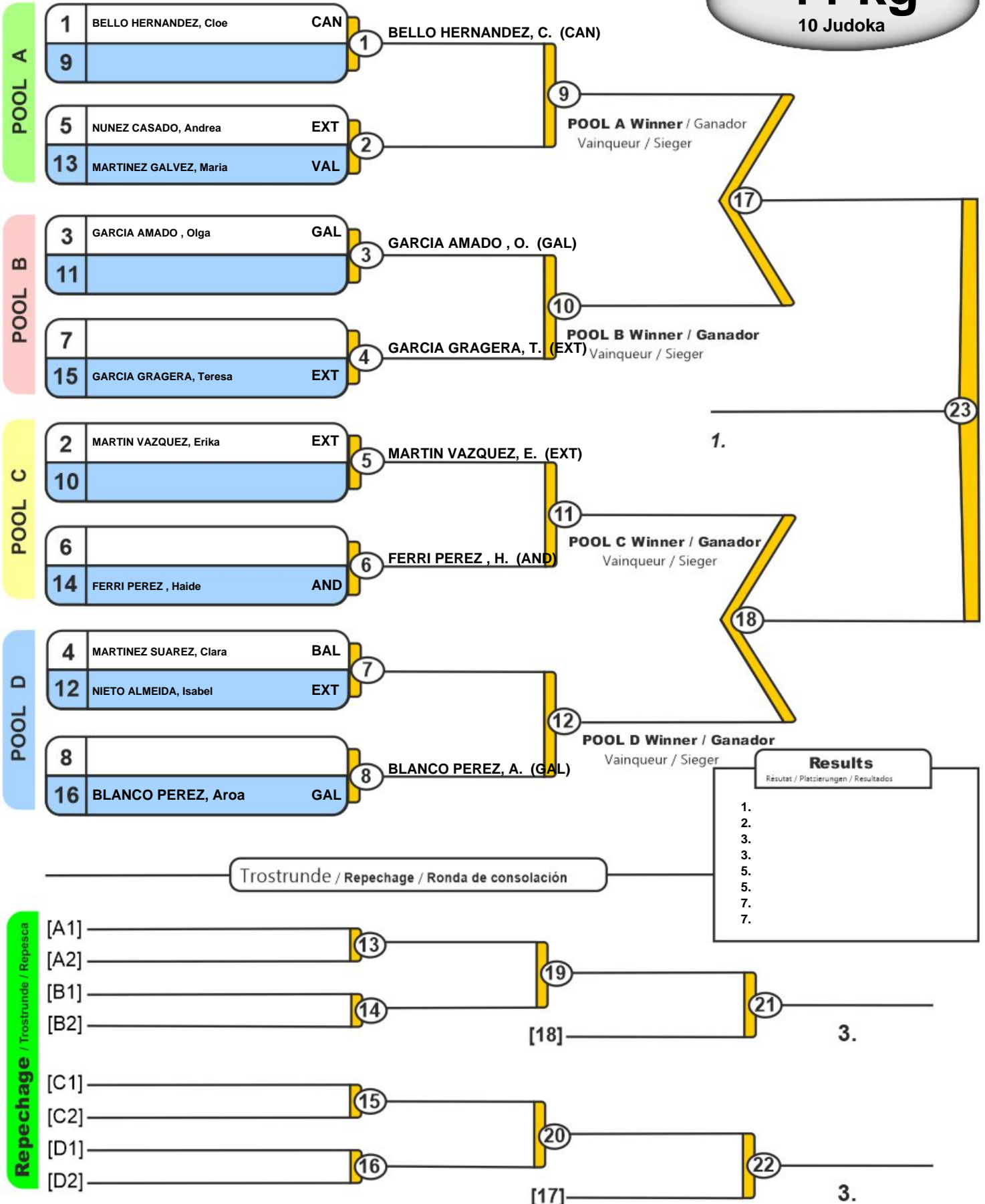

# Copa de España A Don Benito 2023

Don Benito (ESP), 13 May 2023

## -48 kg

15 Judoka

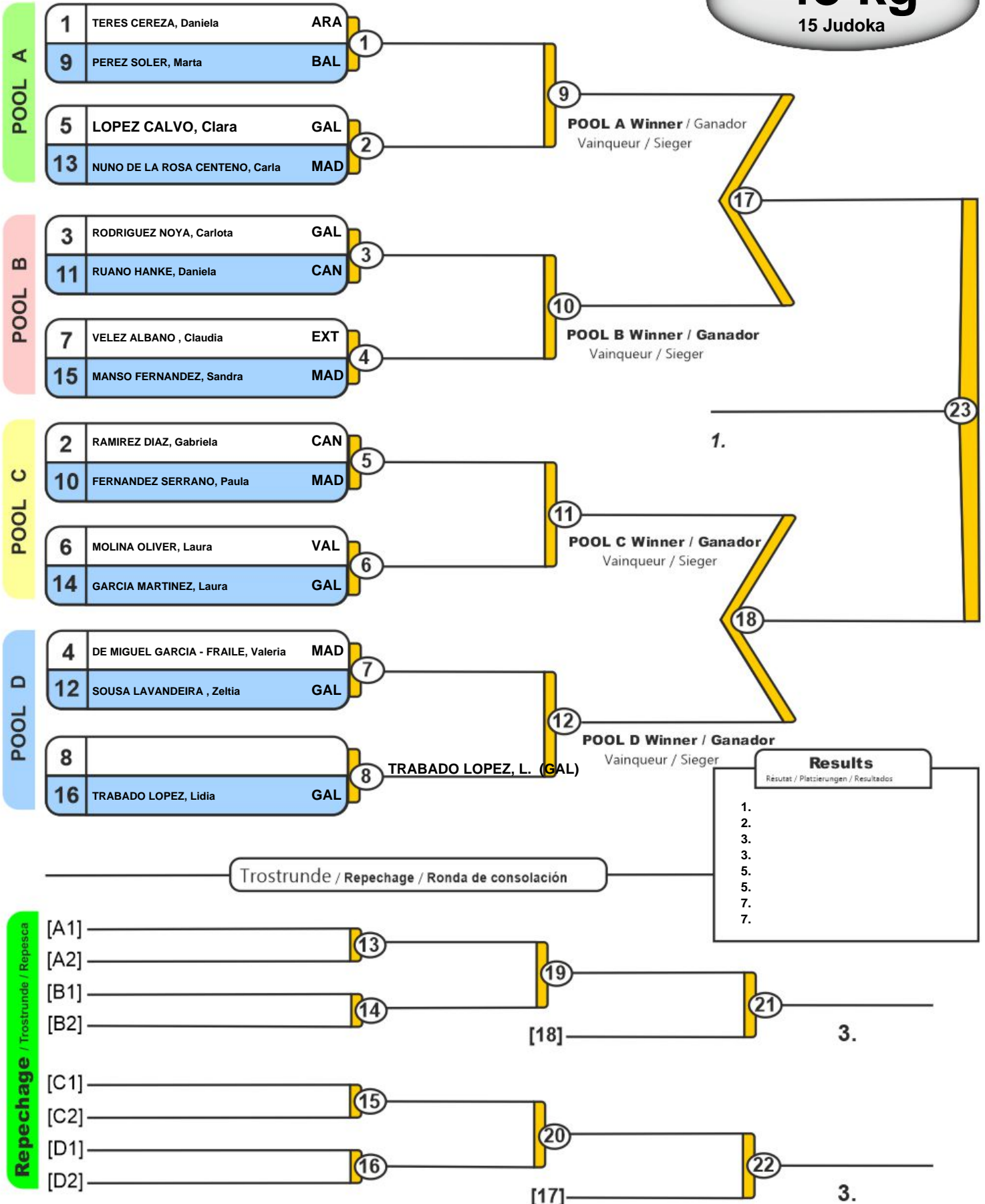

# Copa de Espana A Don Benito 2023

Don Benito (ESP), 13 May 2023

## -52 kg

27 Judoka

POOL A

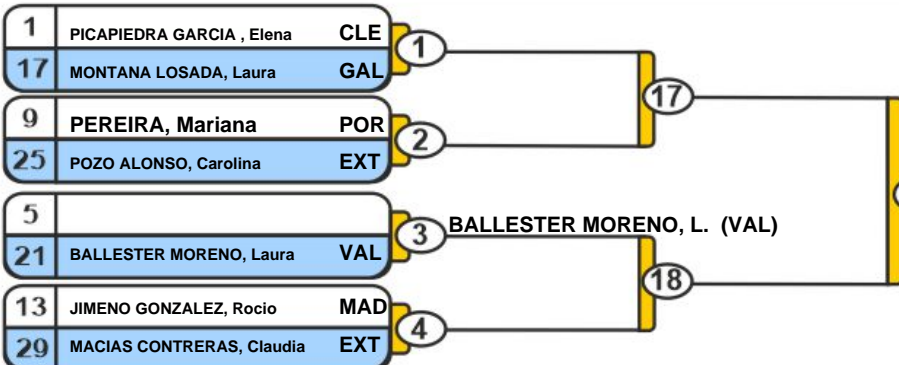

POOL B

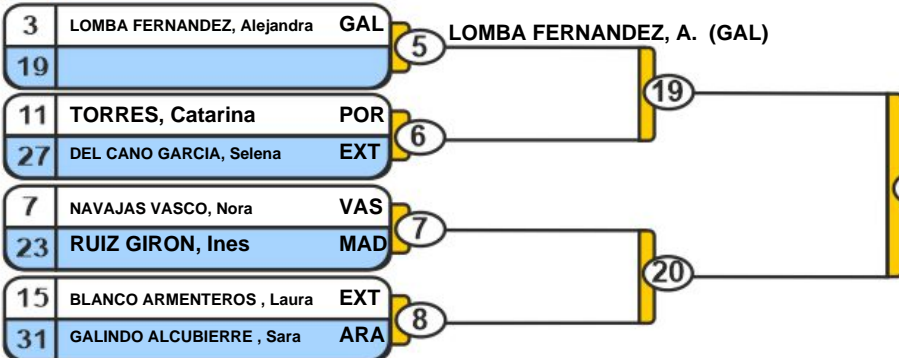

POOL C

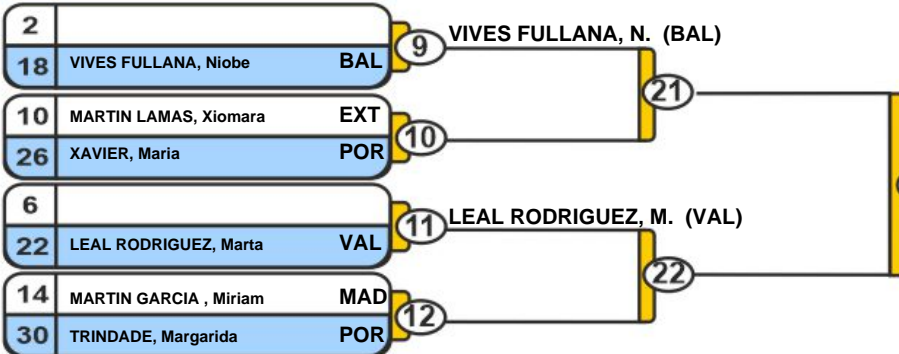

POOL D

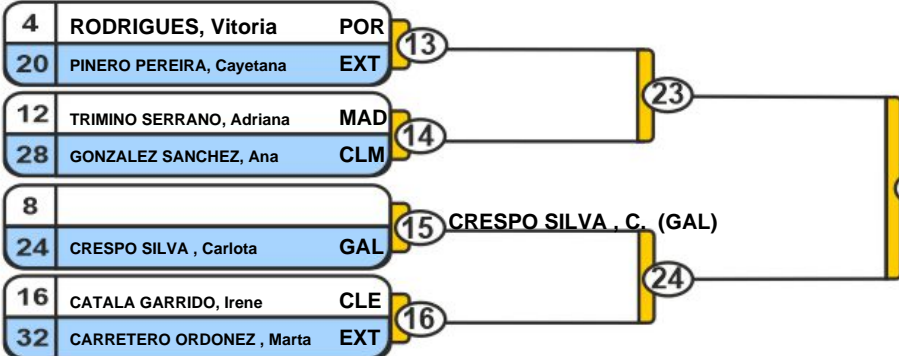

1.

43

### Results

Résultat / Platzierungen / Resultados

- 1.
- 2.
- 3.
- 3.
- 5.
- 5.
- 7.
- 7.

### Trostrunde / Repechage / Ronda de consolación

Repechage / Trostrunde / Repechage

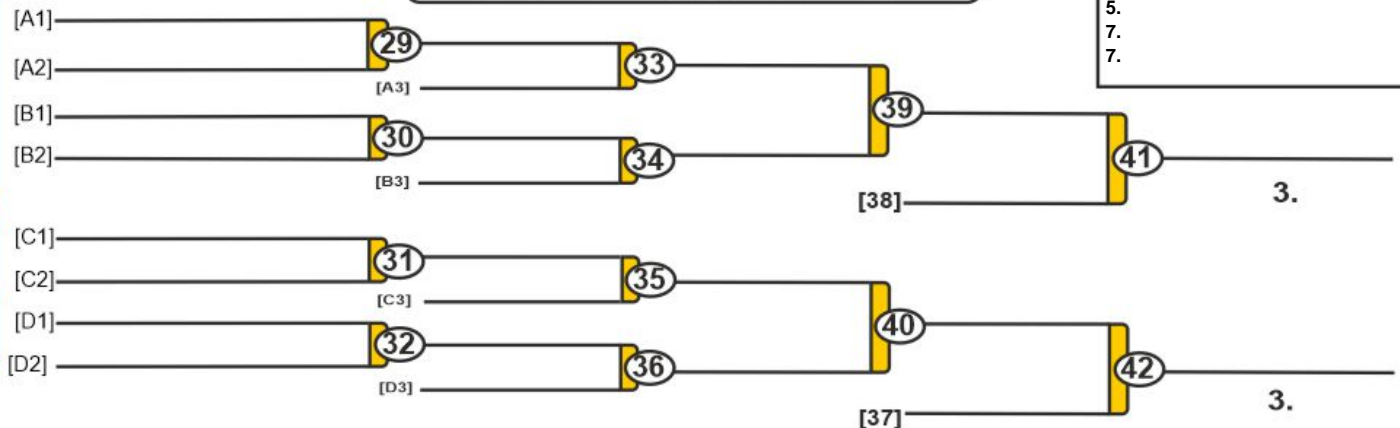

# Copa de Espana A Don Benito 2023

Don Benito (ESP), 13 May 2023

## -57 kg

18 Judoka

POOL A

|    |                        |     |                         |
|----|------------------------|-----|-------------------------|
| 1  |                        | 1   | AURIN LLERINS, M. (ARA) |
| 17 | AURIN LLERINS, Martina | ARA |                         |
| 9  | CORDERO PEREZ, Yaiza   | EXT | 2                       |
| 25 |                        |     | CORDERO PEREZ, Y. (EXT) |
| 5  | GARCIA PONCE, Leire    | MAD | 3                       |
| 21 |                        |     | GARCIA PONCE, L. (MAD)  |
| 13 | DIAZ HERRADOR, Mabel   | CLM | 4                       |
| 29 | MACOVEI, Laura         | POR |                         |

POOL B

|    |                            |     |                              |
|----|----------------------------|-----|------------------------------|
| 3  |                            | 5   | CASTRO FERNANDEZ, P. (MAD)   |
| 19 | CASTRO FERNANDEZ, Pilar    | MAD |                              |
| 11 |                            | 6   | GALINDO ALCUBIERRE, E. (ARA) |
| 27 | GALINDO ALCUBIERRE, Esther | ARA |                              |
| 7  | DINIS, Laura               | POR | 7                            |
| 23 |                            |     | DINIS, Laura (POR)           |
| 15 | CLEMENTE RUANO, Montana    | EXT | 8                            |
| 31 |                            |     | CLEMENTE RUANO, M. (EXT)     |

POOL C

|    |                           |     |                            |
|----|---------------------------|-----|----------------------------|
| 2  | BETTENCOURT, Maria        | POR | 9                          |
| 18 | JOVER VALENCIA, Maria     | MAD |                            |
| 10 | GUERRERO RAMIREZ, Daniela | EXT | 10                         |
| 26 |                           |     | GUERRERO RAMIREZ, D. (EXT) |
| 6  | ROCHA MIRANDA, Alicia     | GAL | 11                         |
| 22 |                           |     | ROCHA MIRANDA, A. (GAL)    |
| 14 |                           | 12  | CAFFERATA STOCK, S. (ARA)  |
| 30 | CAFFERATA STOCK, Sofia    | ARA |                            |

POOL D

|    |                          |     |                            |
|----|--------------------------|-----|----------------------------|
| 4  |                          | 13  | COSTA, Joana (POR)         |
| 20 | COSTA, Joana             | POR |                            |
| 12 |                          | 14  | ALONSO FERNANDEZ, S. (VAL) |
| 28 | ALONSO FERNANDEZ, Sara   | VAL |                            |
| 8  | NOVILLO MANTECON, Aitana | MAD | 15                         |
| 24 |                          |     | NOVILLO MANTECON, A. (MAD) |
| 16 | MARRERO SUAREZ, Paola    | CAN | 16                         |
| 32 |                          |     | MARRERO SUAREZ P. (CAN)    |

Trostrunde / Repechage / Ronda de consolación

Repechage / Trostrunde / Repechage

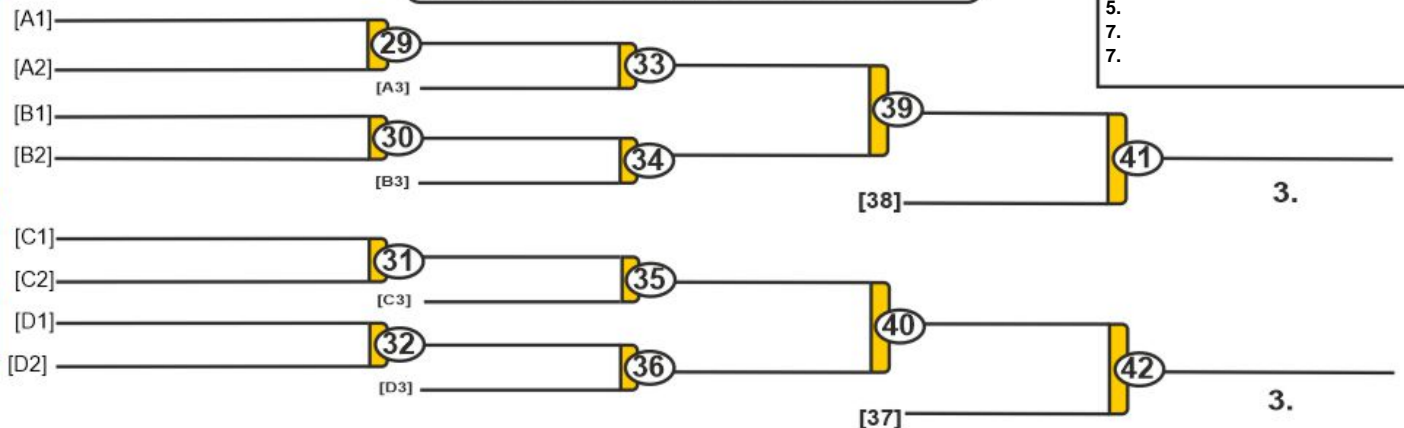

1.

43

POOL C Winner / Ganador  
Vainqueur / Sieger

POOL D Winner / Ganador  
Vainqueur / Sieger

Results

Résultat / Platzierungen / Resultados

- 1.
- 2.
- 3.
- 5.
- 5.
- 7.
- 7.

3.

3.

# Copa de Espana A Don Benito 2023

Don Benito (ESP), 13 May 2023

## -63 kg

14 Judoka

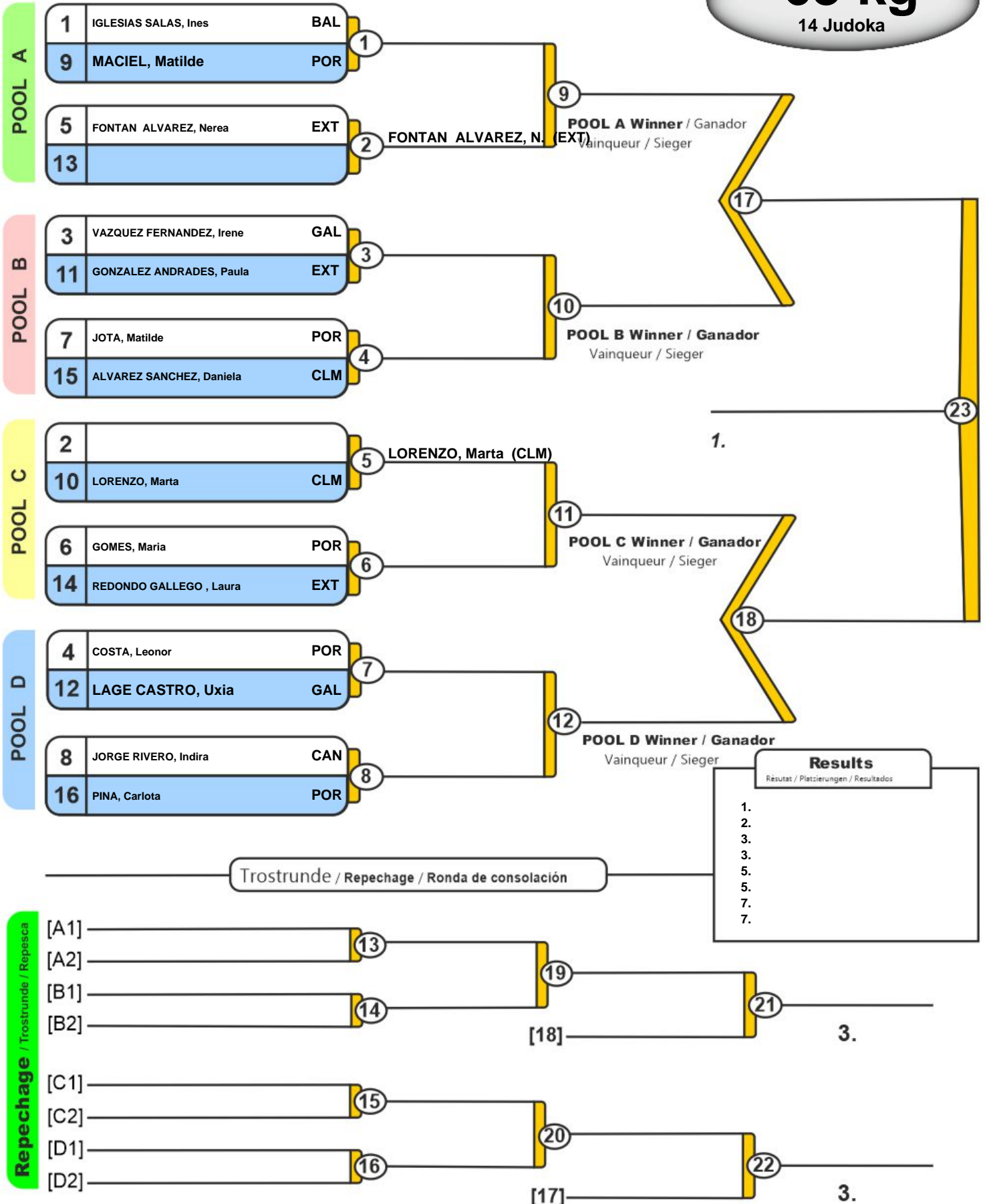

# Copa de Espana A Don Benito 2023

Don Benito (ESP), 13 May 2023

## -70 kg

10 Judoka

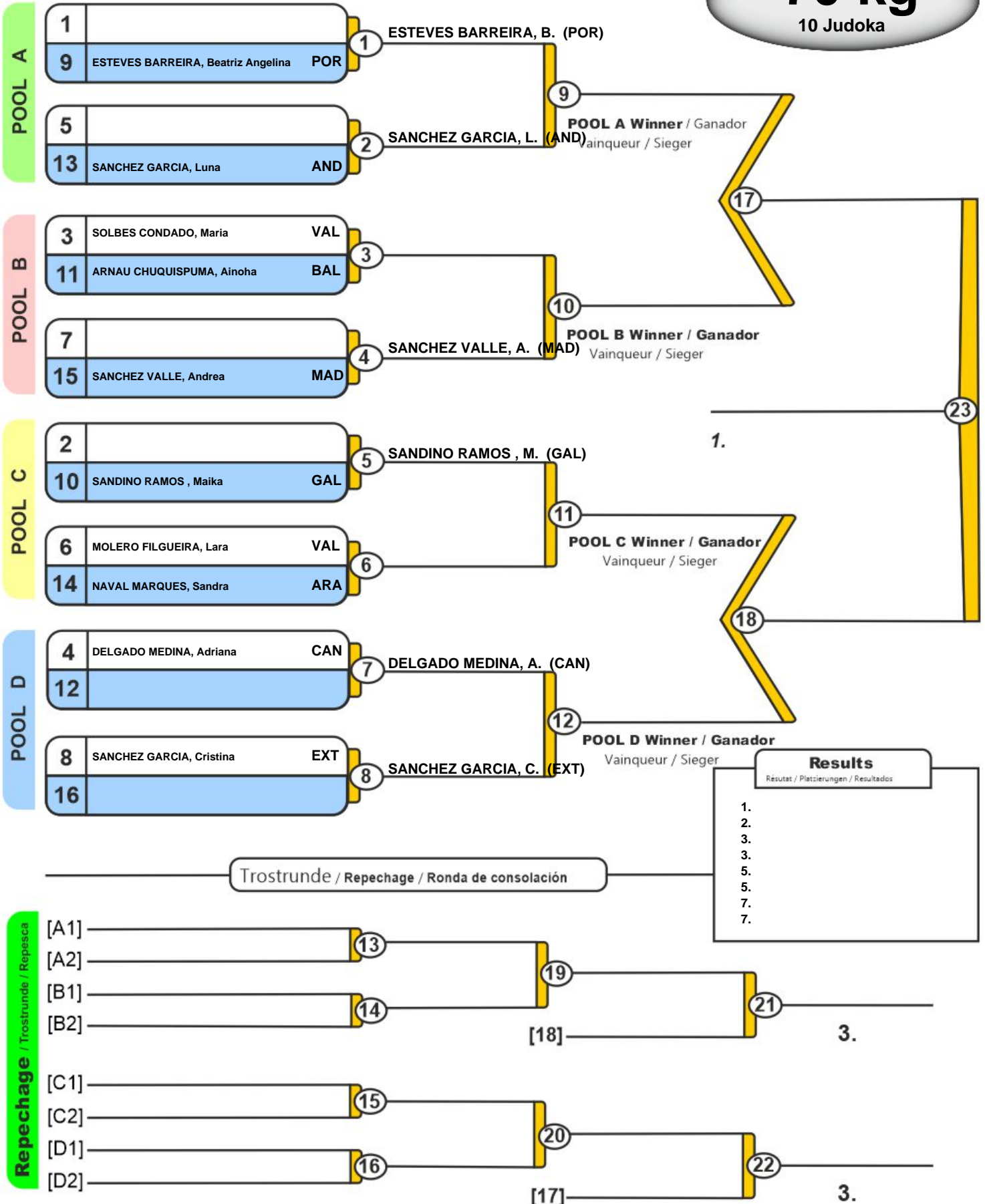

# Copa de España A Don Benito 2023

Don Benito (ESP), 13 May 2023

**+70 kg**  
6 Judoka

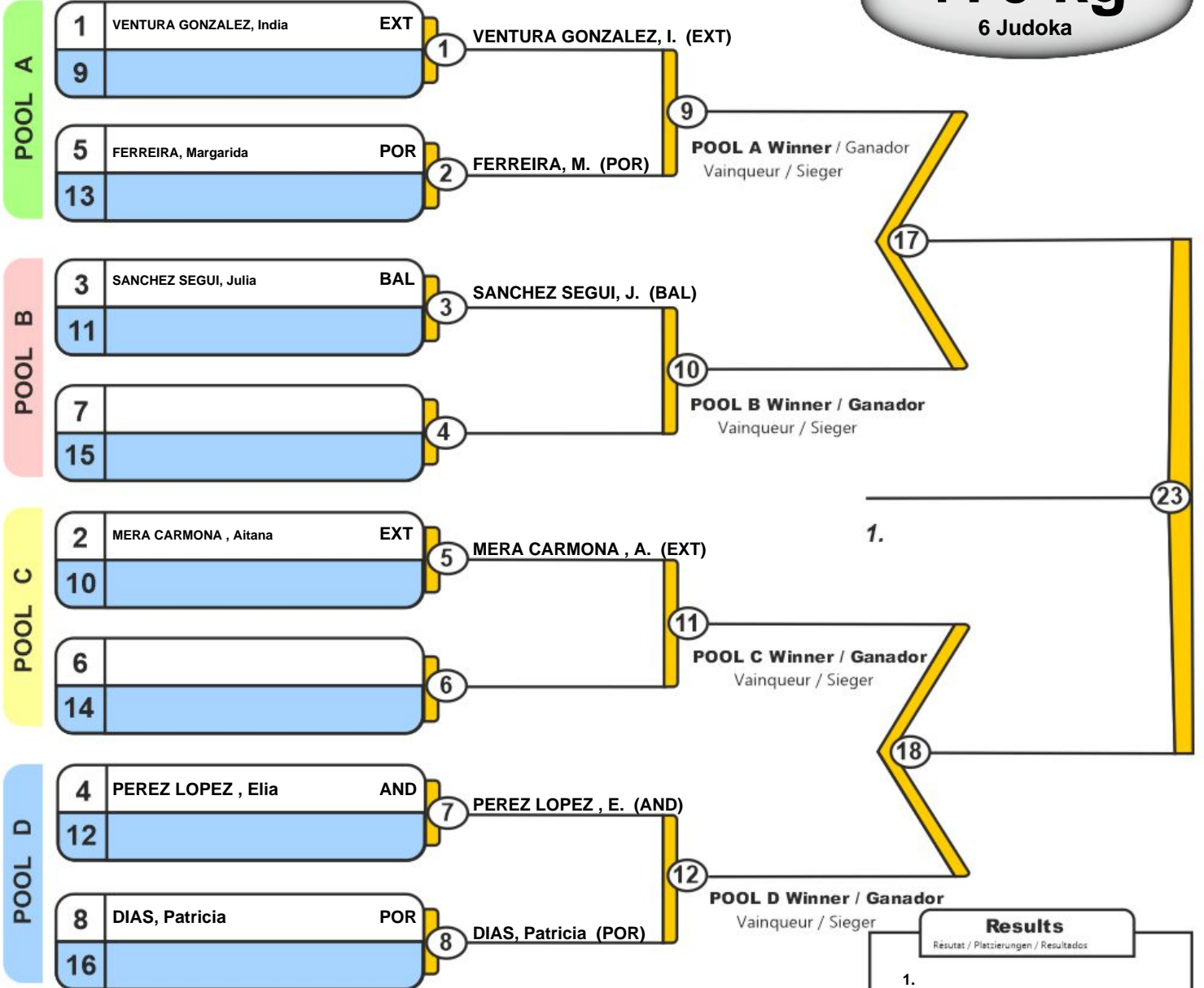

Trostrunde / Repechage / Ronda de consolación

| Results                               |  |
|---------------------------------------|--|
| Résultat / Platzierungen / Resultados |  |
| 1.                                    |  |
| 2.                                    |  |
| 3.                                    |  |
| 3.                                    |  |
| 5.                                    |  |
| 7.                                    |  |
| 7.                                    |  |

