

Supercopa de Espana Infantil Montijo

Montijo (ESP), 18 Feb 2023

-38 kg

17 Judoka

POOL A

1	YAGUE LANCHA, Ruben	MAD	1	YAGUE LANCHA, R. (MAD)
17			17	
9			2	SILVA, Alexandre (POR)
25	SILVA, Alexandre	POR	25	
5			3	PAULA, Lourenco (POR)
21	PAULA, Lourenco	POR	18	
13			4	PRIETO REBOREDO, J. (GAL)
29	PRIETO REBOREDO, Jose Antonio	GAL	20	

POOL A Winner / Ganador
Vainqueur / Sieger

POOL B

3	CEDRES ALAMO, Pablo	CAN	5	CEDRES ALAMO, P. (CAN)
19			19	
11			6	VEIGA, Francisco (POR)
27	VEIGA, Francisco	POR	26	
7	ALVAREZ CHILLIDA, David	MAD	7	ALVAREZ CHILLIDA, D. (MAD)
23			20	
15	CARBONE, Rodrigo	POR	8	
31	NUNEZ CASTRO, David	EXT	21	

POOL B Winner / Ganador
Vainqueur / Sieger

POOL C

2	CARRAL GARCIA, Alejandro	GAL	9	CARRAL GARCIA, A. (GAL)
18			21	
10	CASTRO VELARDE, Abel	EXT	10	CASTRO VELARDE, A. (EXT)
26			27	
6	CERRILLO LOPEZ, Mateo	GAL	11	CERRILLO LOPEZ, M. (GAL)
22			22	
14			12	NEVES, Pedro (POR)
30	NEVES, Pedro	POR	28	

POOL C Winner / Ganador
Vainqueur / Sieger

POOL D

4	PRADEL ESTEBAN, Enrique	ARA	13	PRADEL ESTEBAN, E. (ARA)
20			23	
12	TEIXEIRA, Gustavo	POR	14	TEIXEIRA, G. (POR)
28			24	
8	CIUCARELLI, Marco	AND	15	CIUCARELLI, M. (AND)
24			24	
16			16	BORGES, Martim (POR)
32	BORGES, Martim	POR	28	

POOL D Winner / Ganador
Vainqueur / Sieger

1.

43

Results

Resultat / Platzierungen / Resultados

- 1.
- 2.
- 3.
- 3.
- 5.
- 5.
- 7.
- 7.

Trostrunde / Repechage / Ronda de consolación

Repechage

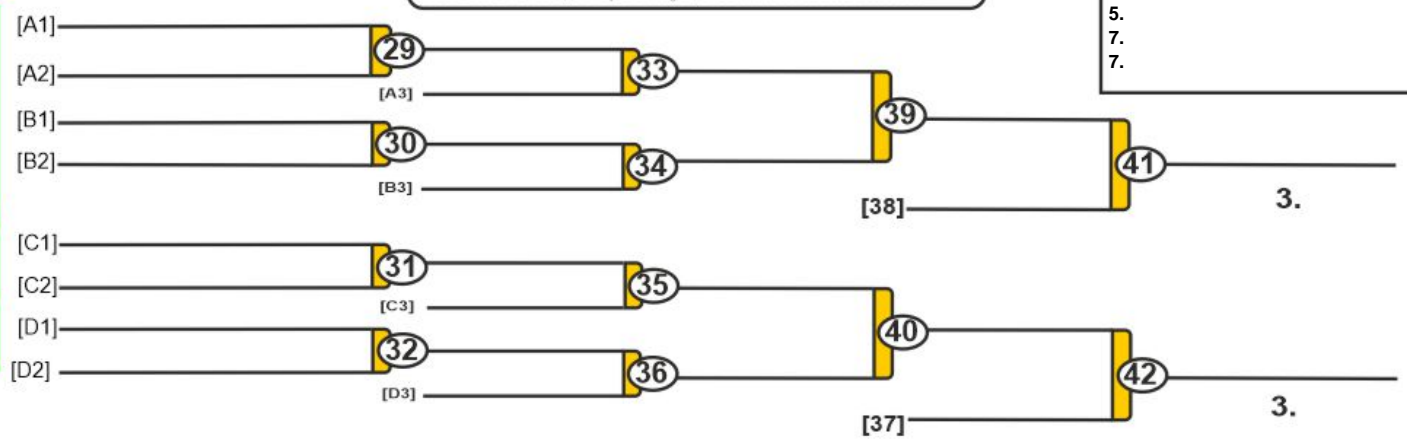

Supercopa de España Infantil Montijo

Montijo (ESP), 18 Feb 2023

-42 kg

21 Judoka

POOL A

1	LAMAS MORENO, Anibal	MAD	1	LAMAS MORENO, A. (MAD)
17			17	
9	OLMO ESTEVEZ, Javier	EXT	2	
25	CRUZ, Gabriel	POR	2	
5	MACCS, Diogo	POR	3	MACCS, Diogo (POR)
21			18	
13			4	DELGADO ARIZA, A. (AND)
29	DELGADO ARIZA, Aharon	AND	4	

POOL B

3	CHIARRONI CUTILLAS, Alejandro	MAD	5	CHIARRONI CUTILLAS, A. (MAD)
19			19	
11			6	SARAIVA, Ricardo (POR)
27	SARAIVA, Ricardo	POR	6	
7	BLASCO PEREZ, Imanol	RIO	7	BLASCO PEREZ, I. (RIO)
23			20	
15	PRIETO MUNOZ, Alex	EXT	8	
31	PABLO VERA, Andres	MAD	8	

POOL C

2	FLUERICA, Madalin	ARA	9	FLUERICA, M. (ARA)
18			21	
10	MINAYA RODRIGUEZ, Alvaro	MAD	10	
26	RIGOTE RODRIGUEZ, Eusebio	EXT	10	
6	FARIA, Simao	POR	11	FARIA, Simao (POR)
22			22	
14	BURLACU, Vlad Andreas	MAD	12	BURLACU, V. (MAD)
30				

POOL D

4	MELIAN GARCIA, Carlos	CAN	13	MELIAN GARCIA, C. (CAN)
20			23	
12	DIAS, Eduardo	POR	14	
28	CASTELLO PEREZ, Unai	MAD	14	
8	BLANCO LLUCH, Pol	ARA	15	BLANCO LLUCH, P. (ARA)
24			24	
16	ARDILA VAQUERO, Fran	EXT	16	
32	GARCIA-PLATA ORTIZ-VILLAJOS, J	MAD	16	

Trostrunde / Repechage / Ronda de consolación

Repechage / Trostrunde / Repeche

[A1]		29		33		
[A2]			[A3]			
[B1]		30		34		39
[B2]			[B3]			
[C1]		31		35		[38]
[C2]			[C3]			
[D1]		32		36		40
[D2]			[D3]			

POOL A Winner / Ganador
Vainqueur / Sieger

POOL B Winner / Ganador
Vainqueur / Sieger

POOL C Winner / Ganador
Vainqueur / Sieger

POOL D Winner / Ganador
Vainqueur / Sieger

Results

Résultat / Platzierungen / Resultados

- 1.
- 2.
- 3.
- 3.
- 5.
- 5.
- 7.
- 7.

Supercopa de Espana Infantil Montijo

Montijo (ESP), 18 Feb 2023

-46 kg

17 Judoka

POOL A

1	PALOMARES LABRADOR, Jon And	GLE	1	PALOMARES LABRADOR, J. (GLE)
17			17	
9			2	JIMENEZ TRUJEQUE, G. (VAL)
25	JIMENEZ TRUJEQUE, Gabriel	VAL	25	
5	LEMONS RODRIGUEZ, Omar	ARA	3	LEMONS RODRIGUEZ, O. (ARA)
21			18	
13			4	OVALLE DE LA CUESTA, M. (MAD)
29	OVALLE DE LA CUESTA, Martin	MAD	4	

POOL A Winner / Ganador
Vainqueur / Sieger

POOL B

3	CEBALLOS BETANCOR, Alejandro	CAN	5	CEBALLOS BETANCOR, A. (CAN)
19			19	
11	GALINANES OSORIO, Teo	GAL	6	GALINANES OSORIO, T. (GAL)
27			20	
7	ANORO TORRES, Alberto	ARA	7	ANORO TORRES, A. (ARA)
23			20	
15	PESSOA, Tomas	POR	8	PESSOA, Tomas (POR)
31			8	

POOL B Winner / Ganador
Vainqueur / Sieger

POOL C

2	POLO LAGUNA, Martin	ARA	9	POLO LAGUNA, M. (ARA)
18			21	
10	HERNANDEZ MADRUGA, Raul	EXT	10	
26	BENAVENTE FERNANDEZ, Erik	MAD	10	
6			11	FAISCA, Rodrigo (POR)
22	FAISCA, Rodrigo	POR	22	
14	ALVAREZ LOMBA, Lucas	GAL	12	ALVAREZ LOMBA, L. (GAL)
30			22	

POOL C Winner / Ganador
Vainqueur / Sieger

POOL D

4	VICENS RODRIGUEZ DE LIEBANA, A. (VAL)	VAL	13	VICENS RODRIGUEZ DE LIEBANA, A. (VAL)
20			23	
12			14	JOVER ADRIAN, M. (MAD)
28	JOVER ADRIAN, Marcos	MAD	28	
8	BIOSCA GARCIA, Renat	VAL	15	BIOSCA GARCIA, R. (VAL)
24			24	
16	BARATA, Gustavo	POR	16	BARATA, Gustavo (POR)
32			24	

POOL D Winner / Ganador
Vainqueur / Sieger

1.

43

Results

Résultat / Platzierungen / Resultados

- 1.
- 2.
- 3.
- 3.
- 5.
- 5.
- 7.
- 7.

Trostrunde / Repechage / Ronda de consolación

Repechage / Trostrunde / Repechage

[A1]		29		33		
[A2]			[A3]			
[B1]		30		34		39
[B2]			[B3]			
[C1]		31		35		[38]
[C2]			[C3]			
[D1]		32		36		40
[D2]			[D3]			
						[37]

3.

3.

Supercopa de Espana Infantil Montijo

Montijo (ESP), 18 Feb 2023

-50 kg

25 Judoka

POOL A

1	LAGO PEREZ, Pancho	GAL	1	LAGO PEREZ, P. (GAL)
17			17	
9	MELIAN GARCIA, Pablo	CAN	2	
25	MACHADO, Andre	POR	25	
5	DE LA CRUZ PINEDA, Joaquin	AND	3	
21	DIAS, Rodrigo	POR	18	
13	SANCHEZ DOBON, Eduardo	VAL	4	
29	ROMERO GONZALEZ, Fernando	EXT	18	

POOL A Winner / Ganador
Vainqueur / Sieger

POOL B

3	SANCHEZ GARCIA, Miguel	MAD	5	SANCHEZ GARCIA, M. (MAD)
19			19	
11	ROSA, Afonso	POR	6	
27	PALOMINO HERNANDEZ, Aaron	EXT	26	
7	OVALLE DE LA CUESTA, Luis	MAD	7	OVALLE DE LA CUESTA, L. (MAD)
23			20	
15	MENDONCA, Rafael	POR	8	
31	CASAL GARCIA, Alvaro	GAL	20	

POOL B Winner / Ganador
Vainqueur / Sieger

POOL C

2	MONTES OLIVA, Lucas	ARA	9	MONTES OLIVA, L. (ARA)
18			21	
10	TADEYOSYAN ADAMYAN, David	MAD	10	
26	PINHEIRO, Tomas	POR	27	
6	PARRA RODRIGUEZ, Cristian	AND	11	PARRA RODRIGUEZ, C. (AND)
22			22	
14	HERNANDEZ SOLIS, Daniel	EXT	12	
30	MOTA, Claudio	POR	22	

POOL C Winner / Ganador
Vainqueur / Sieger

POOL D

4	RAMOS POSE, Matias	GAL	13	RAMOS POSE, M. (GAL)
20			23	
12	PADRINO RUIZ, Jaime	MAD	14	
28	LOURO, Martim	POR	28	
8	SANCHEZ MATEOS, Ismael	EXT	15	SANCHEZ MATEOS, I. (EXT)
24			24	
16	LOPEZ TORRES, Ismael	AND	16	
32	SA, Simao	POR	24	

POOL D Winner / Ganador
Vainqueur / Sieger

Trostrunde / Repechage / Ronda de consolación

Repechage

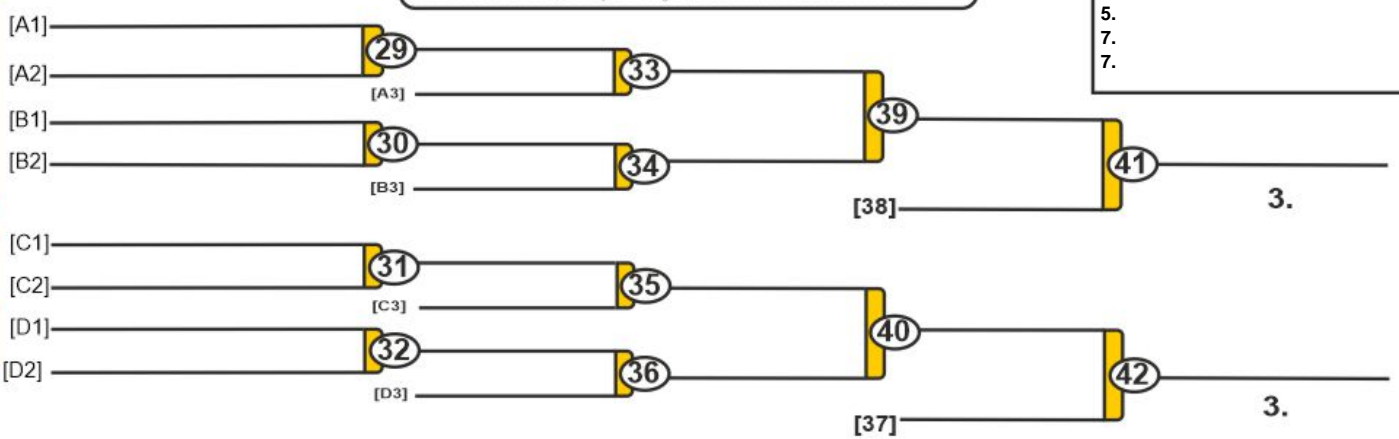

Results	
Résultat / Platzierungen / Resultados	
1.	
2.	
3.	
3.	
5.	
5.	
7.	
7.	

Supercopa de Espana Infantil Montijo

Montijo (ESP), 18 Feb 2023

-55 kg

17 Judoka

POOL A

1	RODRIGUEZ DAVINA, Alberto	GAL	1	RODRIGUEZ DAVINA, A. (GAL)
17			17	
9	FARIA, Dinis	POR	2	FARIA, Dinis (POR)
25			25	
5	INCHAUSTI MARCOS, Alejandro	CLE	3	INCHAUSTI MARCOS, A. (CLE)
21			18	
13	CABELLO GARCIA, Antonio	AND	4	CABELLO GARCIA, A. (AND)
29				

POOL A Winner / Ganador
Vainqueur / Sieger

POOL B

3	LUNA GENOVES, Pablo	VAL	5	LUNA GENOVES, P. (VAL)
19			19	
11			6	ROMEIRO, Diogo (POR)
27	ROMEIRO, Diogo	POR		
7	RYSZARD RADLICA, Adam	MAD	7	RYSZARD RADLICA, A. (MAD)
23			20	
15			8	SILVA, Tiago (POR)
31	SILVA, Tiago	POR		

POOL B Winner / Ganador
Vainqueur / Sieger

POOL C

2	MIGUNOV GOMEZ, Maksim	VAL	9	MIGUNOV GOMEZ, M. (VAL)
18			21	
10	MARTINEZ CASTRO, Fabian	AND	10	
26	CABEDAL, Guilherme	POR		
6			11	SOSA RICO, David (EXT)
22	SOSA RICO, David	EXT		
14	BETCO, Francisco	POR	12	BETCO, Francisco (POR)
30				

POOL C Winner / Ganador
Vainqueur / Sieger

POOL D

4	ROYO SAEZ, Ivan	MAD	13	ROYO SAEZ, I. (MAD)
20			23	
12	RODRIGUEZ RUIZ, Ivan Wen	CAN	14	RODRIGUEZ RUIZ, I. (CAN)
28				
8	ALONSO SAIZ, Daniel	CLE	15	ALONSO SAIZ, D. (CLE)
24			24	
16	FRAZCO, Nuno	POR	16	FRAZCO, Nuno (POR)
32				

POOL D Winner / Ganador
Vainqueur / Sieger

1.

43

Results

Résultat / Platzierungen / Resultados

- 1.
- 2.
- 3.
- 5.
- 5.
- 7.
- 7.

Trostrunde / Repechage / Ronda de consolación

Repechage / Trostrunde / Repecha

[A1]		29		33		
[A2]			[A3]			
[B1]		30		34		39
[B2]			[B3]			
[C1]		31		35		[38]
[C2]			[C3]			
[D1]		32		36		40
[D2]			[D3]			
						[37]

3.

3.

Supercopa de España Infantil Montijo

Montijo (ESP), 18 Feb 2023

-60 kg

22 Judoka

POOL A

1	SANUDO SAMPERIO, Dario	CTB	1	SANUDO SAMPERIO, D. (CTB)
17			17	
9	GOMEZ ANTONA, Javier	MAD	2	
25	VALADES GIL, Hector	EXT	25	
5			3	VAZQUEZ IGLESIAS, M. (GAL)
21	VAZQUEZ IGLESIAS, Martin	GAL	18	
13	LANCIANO REMEDIOS, Darey	CAN	4	
29	LAMEIRA, David	POR	4	

POOL A Winner / Ganador
Vainqueur / Sieger

POOL B

3	GAYOL GRANDA, Gonzalo	MAD	5	GAYOL GRANDA, G. (MAD)
19			19	
11	TARRASON HERNANDEZ, Leo	EXT	6	TARRASON HERNANDEZ, L. (EXT)
27			6	
7	CARDIL BONSON, Hector	ARA	7	CARDIL BONSON, H. (ARA)
23			20	
15	TADEVOSYAN ADAMYAN, Ashot	MAD	8	
31	SOTO CAMPOS, Seil	GAL	8	

POOL B Winner / Ganador
Vainqueur / Sieger

POOL C

2	CABRERA CUENCA, Aaron	CAT	9	CABRERA CUENCA, A. (CAT)
18			21	
10	CAMUNAS DIAZ MINGO, Luis	MAD	10	
26	DIAS, Tiago	POR	10	
6	URIBE RUEDA, Oliver	AND	11	
22	SANCHEZ MARTINEZ, Hector	EXT	11	
14			12	HUERTA MANSILLA, H. (MAD)
30	HUERTA MANSILLA, Hugo	MAD	12	

POOL C Winner / Ganador
Vainqueur / Sieger

POOL D

4	GALINDO MONROS, Marcel	VAL	13	GALINDO MONROS, M. (VAL)
20			23	
12	SILVA, Vicente	POR	14	SILVA, Vicente (POR)
28			23	
8	CLAGER PUYAL, Antonio	ARA	15	CLAGER PUYAL, A. (ARA)
24			24	
16	LAGO ROSELLO, Sergio	GAL	16	
32	LISCA, Raul	MAD	16	

POOL D Winner / Ganador
Vainqueur / Sieger

1.

43

Results

Résultat / Platzierungen / Resultados

- 1.
- 2.
- 3.
- 3.
- 5.
- 5.
- 7.
- 7.

Trostrunde / Repechage / Ronda de consolación

Repechage / Trostrunde / Repechage

[A1]		29		33		
[A2]			[A3]			
[B1]					39	
[B2]		30		34		41
			[B3]			
[C1]						[38]
[C2]		31		35		
			[C3]			
[D1]					40	
[D2]		32		36		42
			[D3]			
						[37]

3.

3.

Supercopa de Espana Infantil Montijo

Montijo (ESP), 18 Feb 2023

-66 kg

17 Judoka

POOL A



POOL B

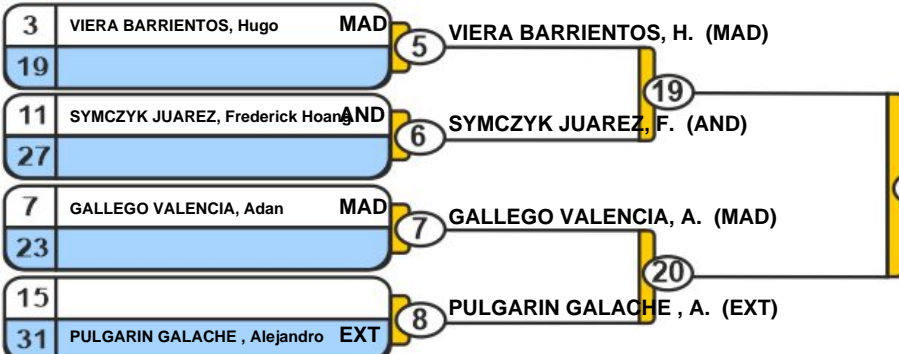

POOL C

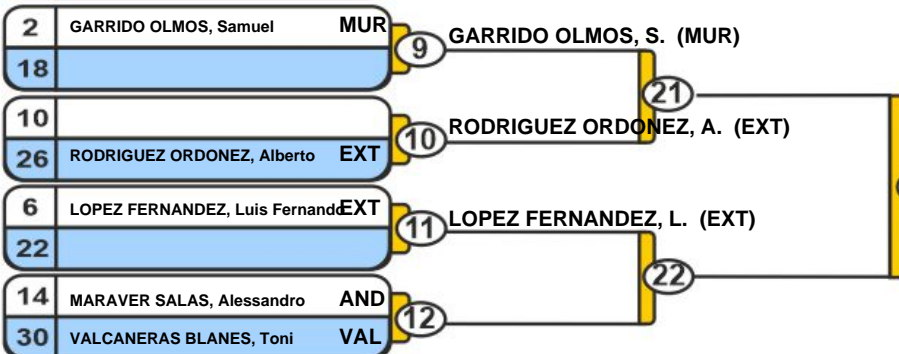

POOL D

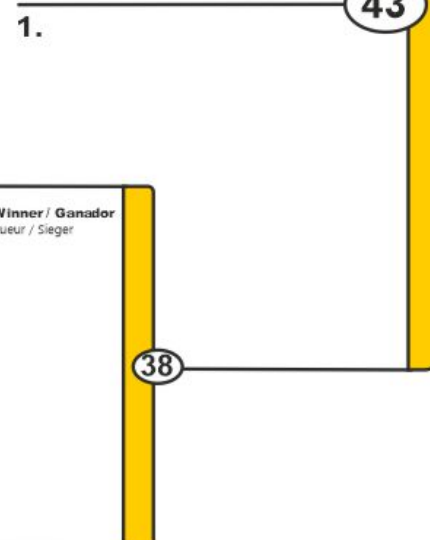
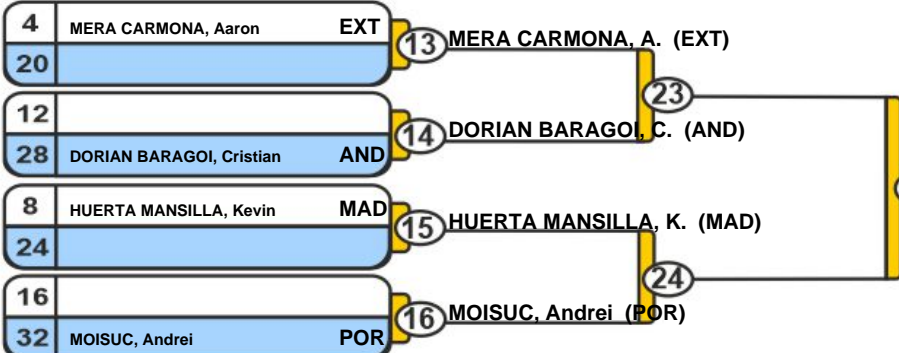

Trostrunde / Repechage / Ronda de consolación

Repechage

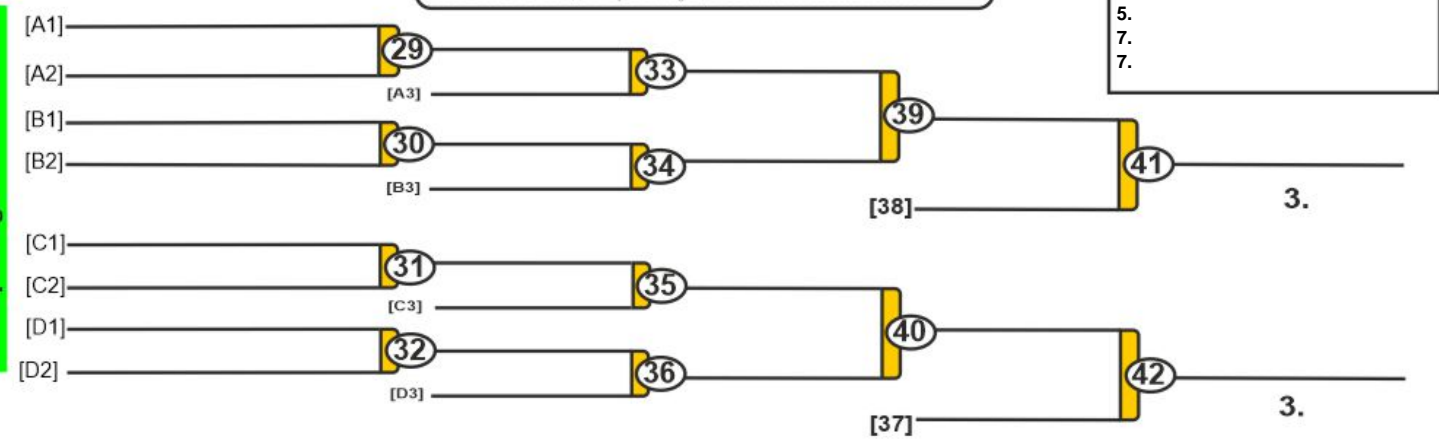

Results	
Résultat / Platzierungen / Resultados	
1.	
2.	
3.	
3.	
5.	
5.	
7.	
7.	

Supercopa de España Infantil Montijo

Montijo (ESP), 18 Feb 2023

+66 kg

13 Judoka

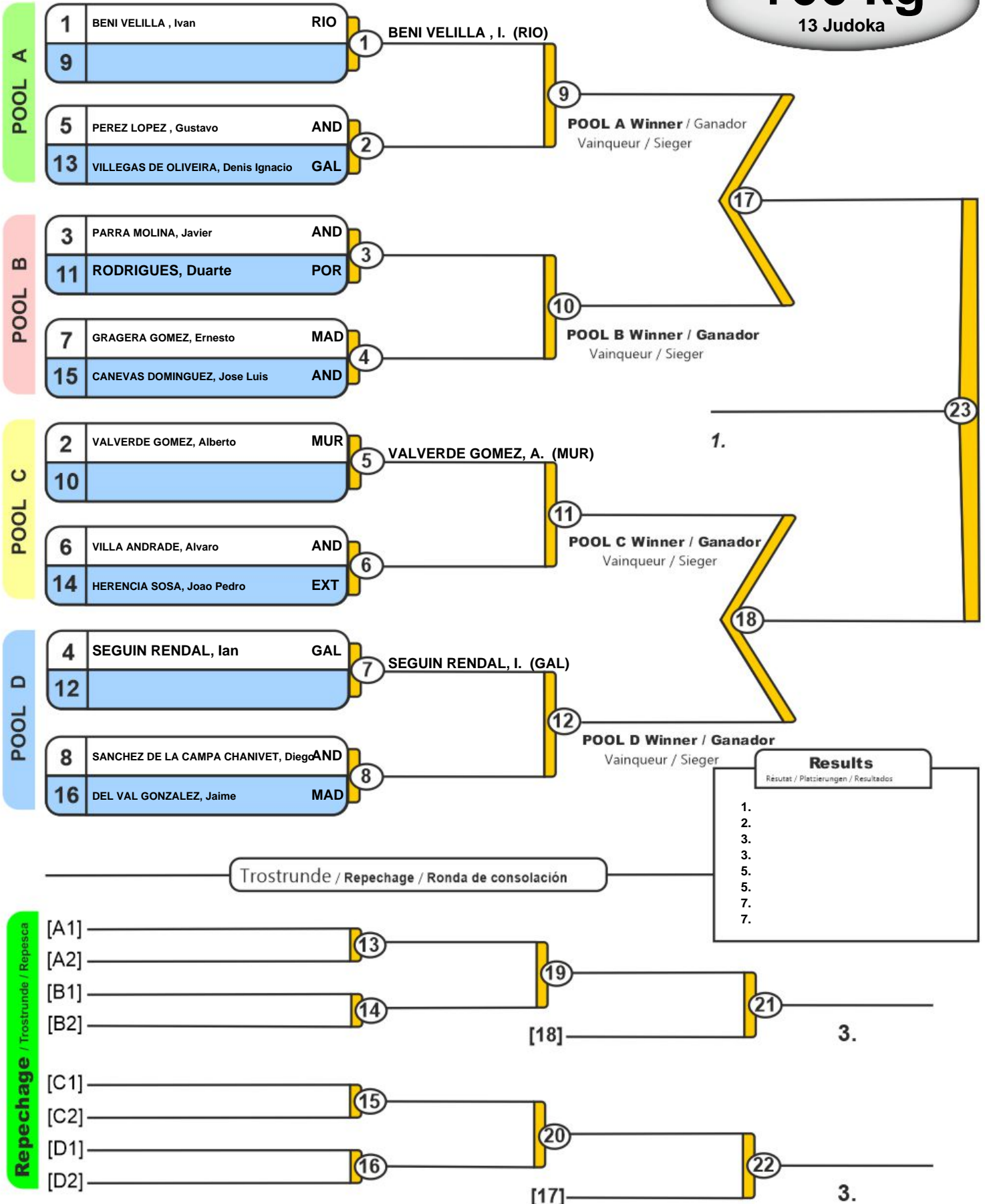

Supercopa de España Infantil Montijo

Montijo (ESP), 18 Feb 2023

-36 kg

6 Judoka

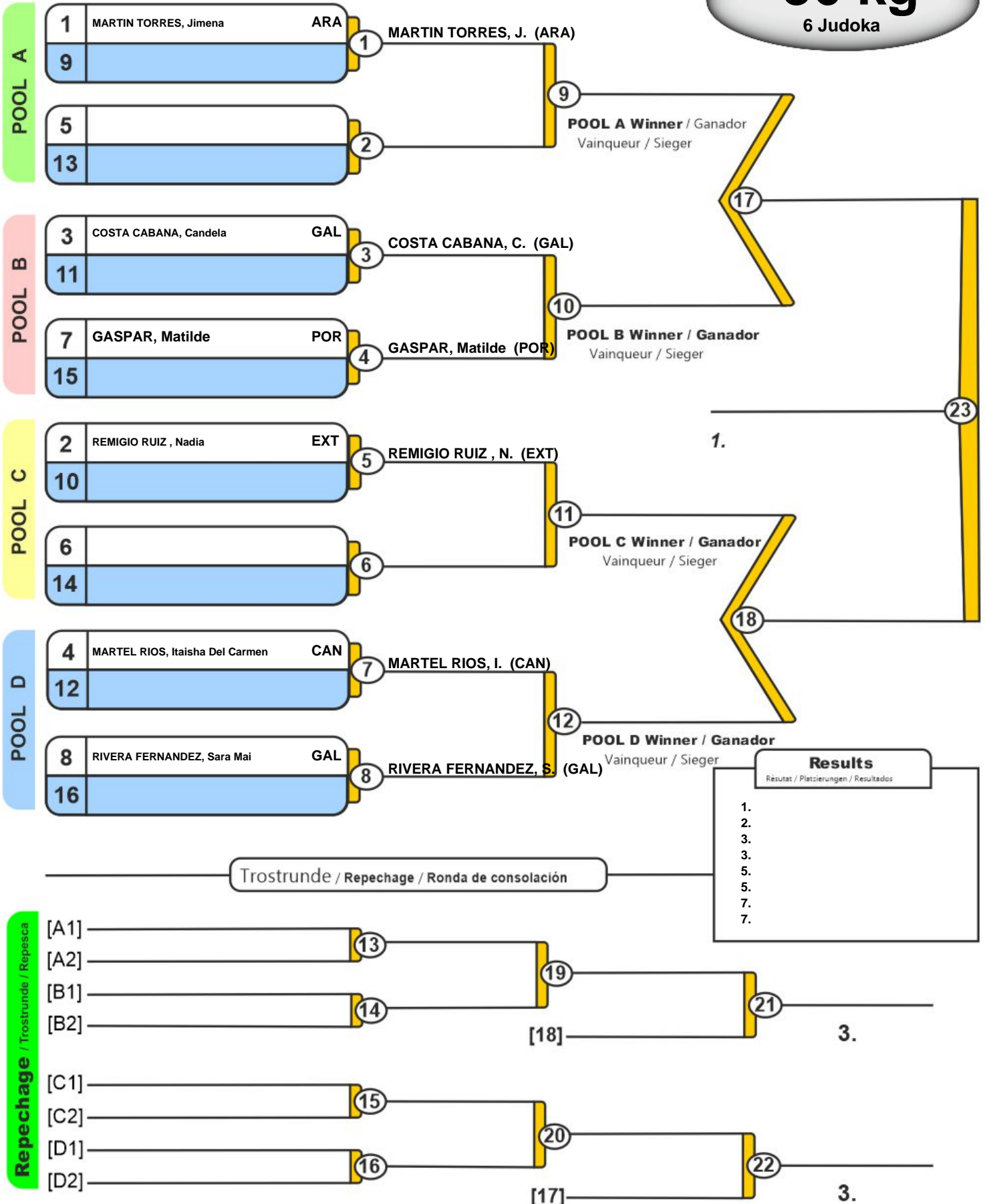

Supercopa de España Infantil Montijo

Montijo (ESP), 18 Feb 2023

-40 kg

10 Judoka

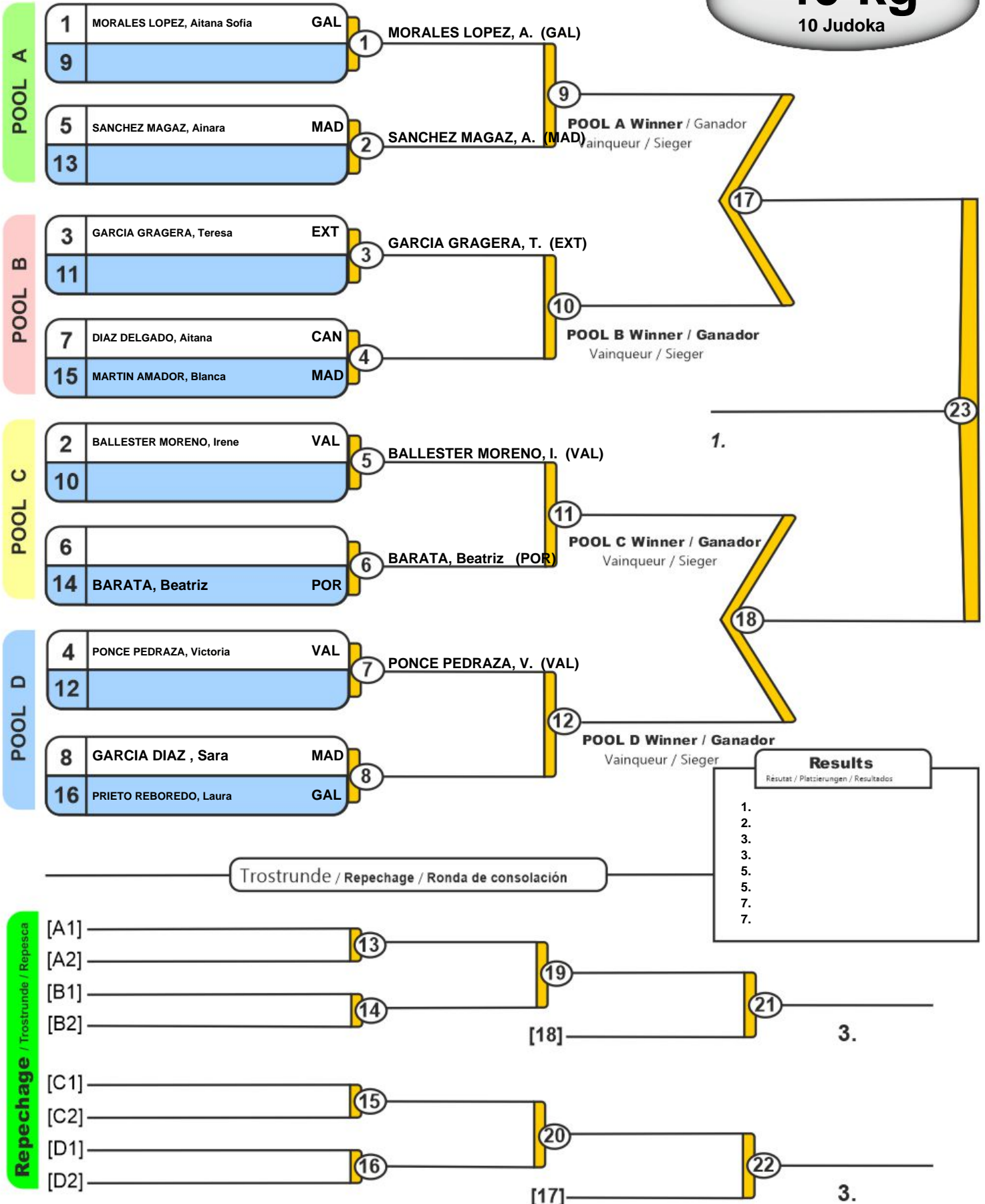

Supercopa de España Infantil Montijo

Montijo (ESP), 18 Feb 2023

-44 kg

11 Judoka

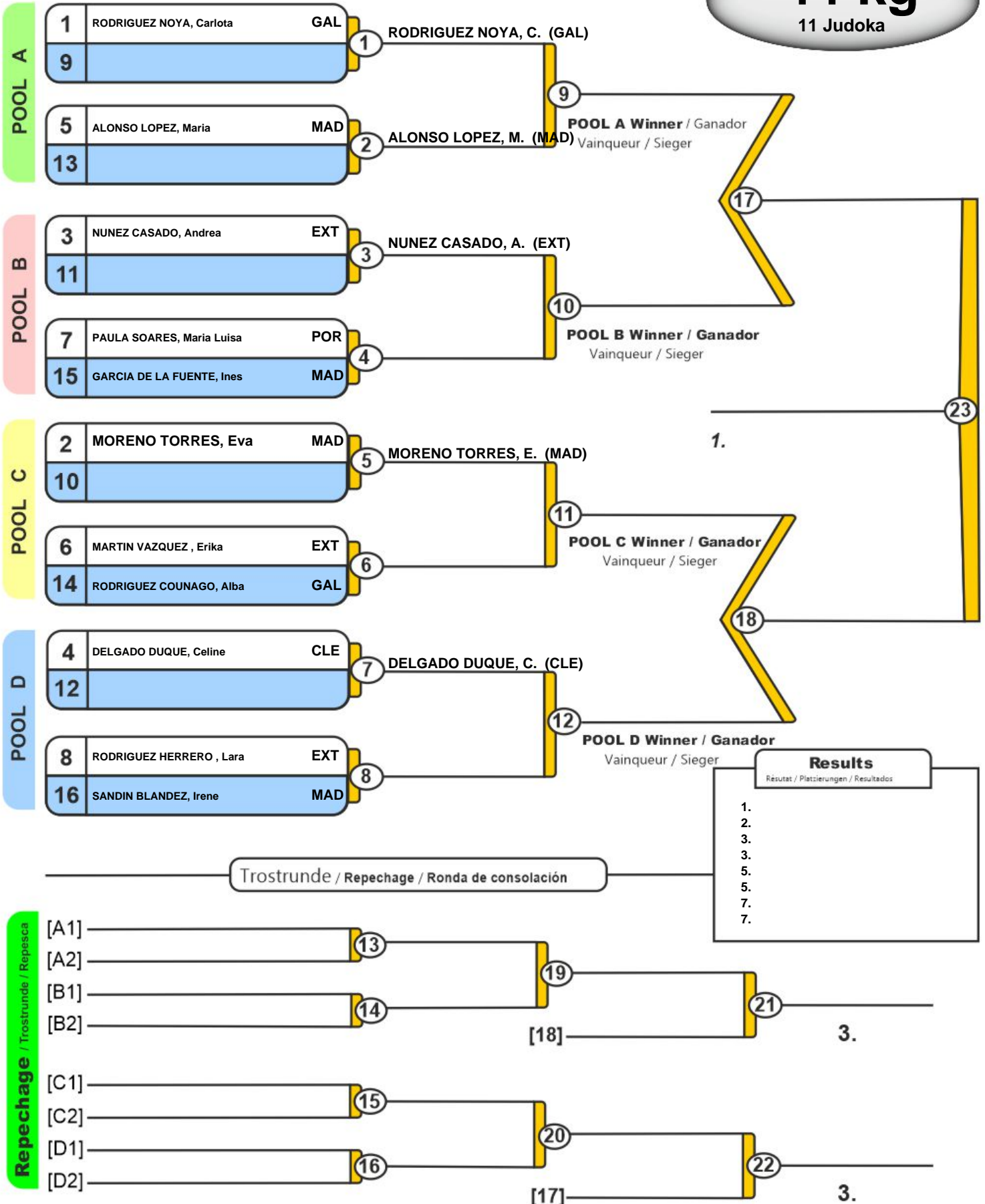

Supercopa de España Infantil Montijo

Montijo (ESP), 18 Feb 2023

-48 kg

13 Judoka

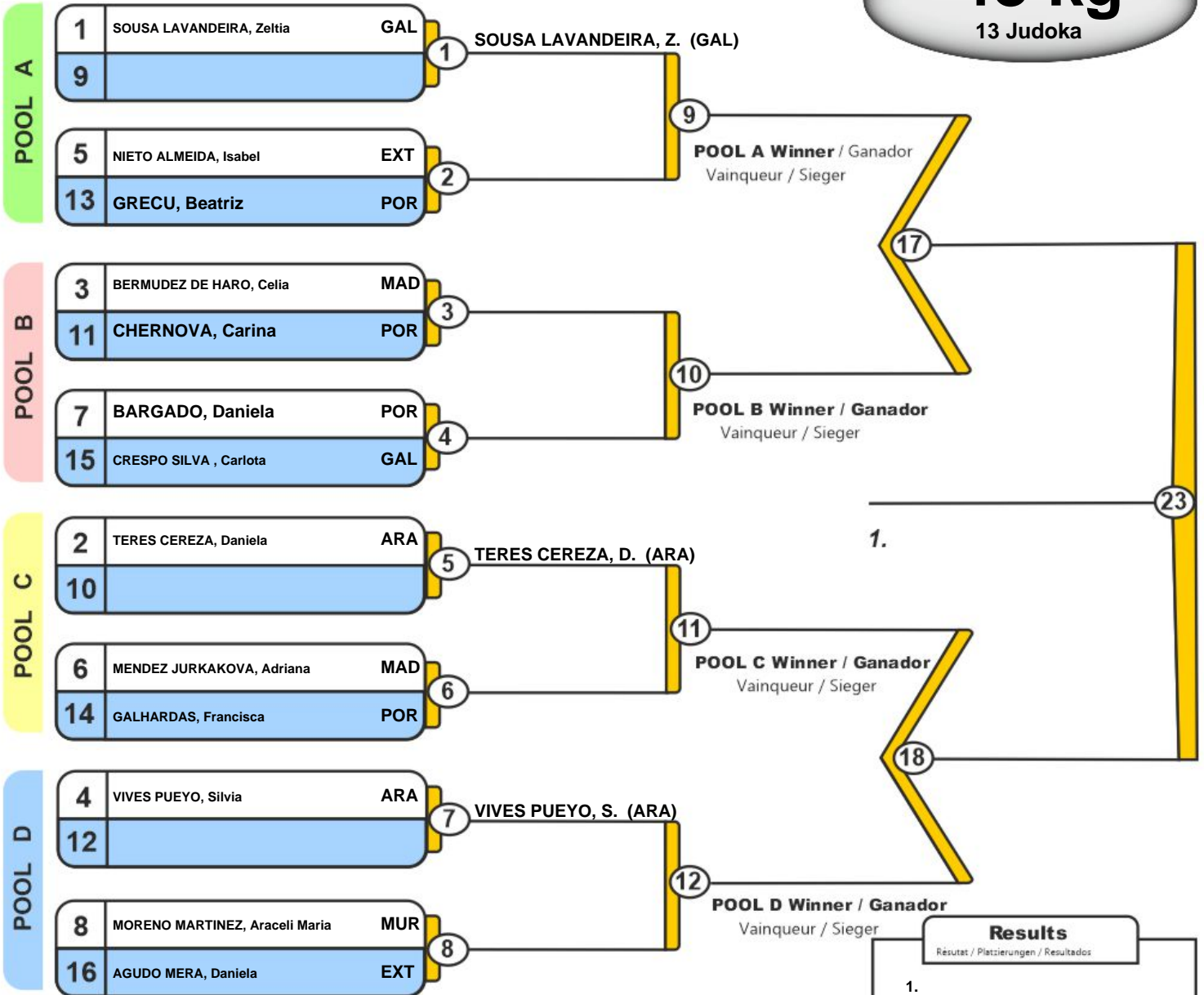

Trostrunde / Repechage / Ronda de consolación

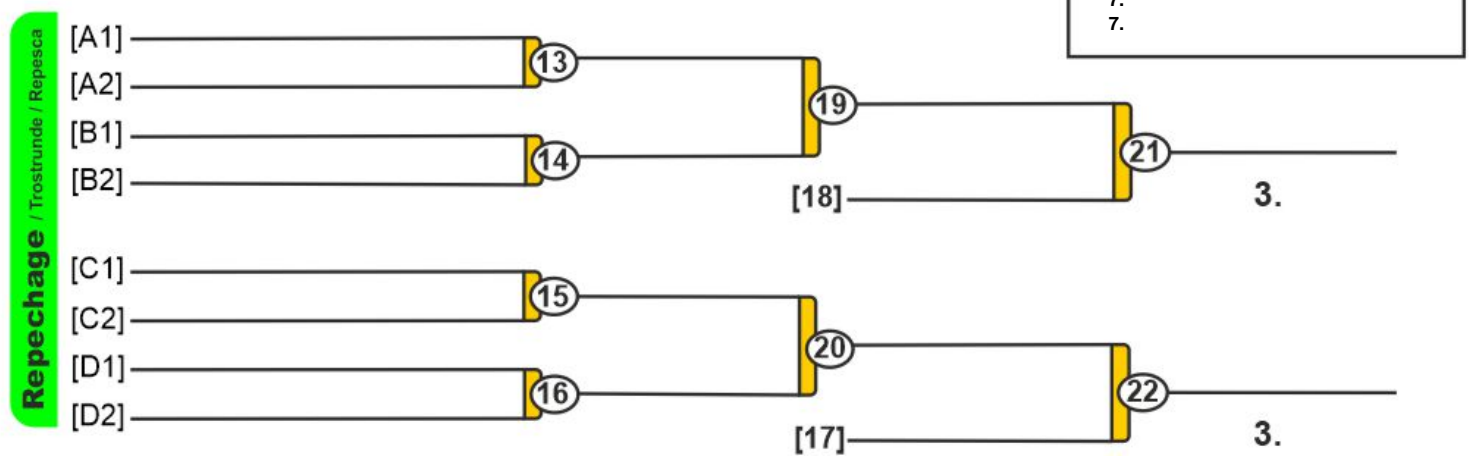

Results	
Resultat / Platzierungen / Resultados	
1.	
2.	
3.	
3.	
5.	
7.	
7.	

Supercopa de España Infantil Montijo

Montijo (ESP), 18 Feb 2023

-52 kg

14 Judoka

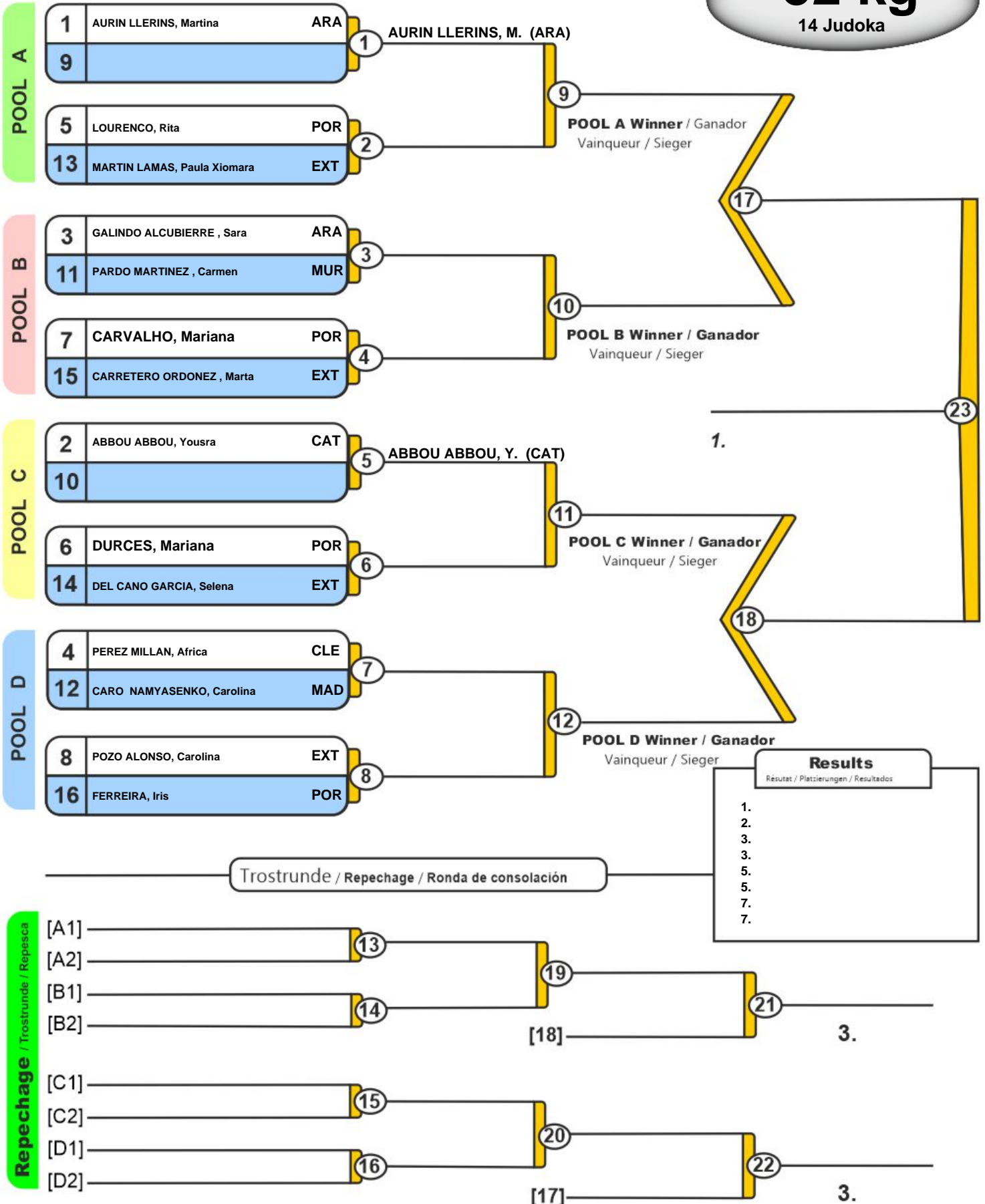

Supercopa de Espana Infantil Montijo

Montijo (ESP), 18 Feb 2023

-57 kg

20 Judoka

POOL A

1 ALONSO FERNANDEZ, Sara VAL ① ALONSO FERNANDEZ, S. (VAL)

17 [] ② MUNOZ TURIEL, N (EXT)

9 MUNOZ TURIEL, Nerea EXT ③ GALINDO ALCUBIERRE, E. (ARA)

25 [] ④ BELTRAN MANZANEQUE, Claudia MAD

5 GALINDO ALCUBIERRE, Esther ARA ⑤ ROCHA MIRANDA, A. (GAL)

13 CIDONCHA HERRERO, Daniela CLE ⑥ RODRIGUEZ CADENAS, Alejandra MAD

29 [] ⑦ DIALLO DIKATE, S. (ARA)

7 DIALLO DIKATE, Sira ARA ⑧ ANTONIO, B. (POR)

15 [] ⑨ SAENZ MARIN, A. (RIO)

31 ANTONIO, Beatriz POR ⑩ FERNANDEZ GOMEZ, Enma GAL

2 [] ⑪ SIMON SANCHEZ, L. (CAN)

18 SAENZ MARIN, Angela RIO ⑫ CARREIRAS, M. (POR)

10 FERNANDEZ GOMEZ, Enma GAL ⑬ NAVARRETE GEA, C. (VAL)

26 TORRES MARIA, Adriana CLE ⑭ CAFFERATA STOCK, S. (ARA)

6 SIMON SANCHEZ, Laura CAN ⑮ JOVER VALENCIA, M. (MAD)

22 [] ⑯ JOVER VALENCIA, M. (MAD)

14 CARREIRAS, Marta POR ⑰ GUERRERO RAMIREZ, Daniela EXT

30 [] ⑱ COELHO, Madalena POR

POOL B

POOL C

POOL D

Repechage / Trostrunde / Repeche

POOL A Winner / Ganador
Vainqueur / Sieger

POOL B Winner / Ganador
Vainqueur / Sieger

POOL C Winner / Ganador
Vainqueur / Sieger

POOL D Winner / Ganador
Vainqueur / Sieger

1.

37

43

38

Results

Résultat / Platzierungen / Resultados

- 1.
- 2.
- 3.
- 5.
- 5.
- 7.
- 7.

Trostrunde / Repechage / Ronda de consolación

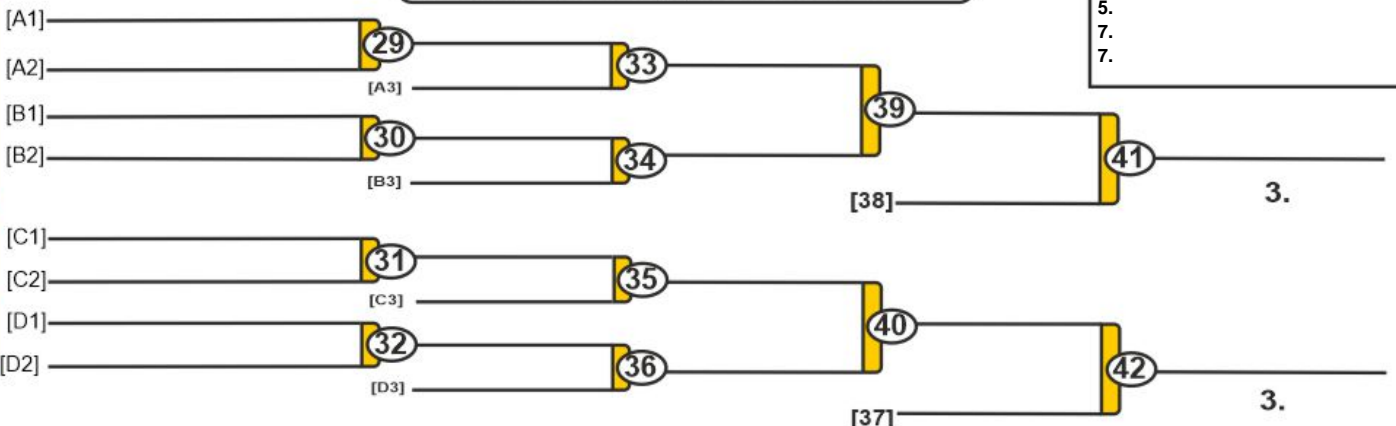

Supercopa de Espana Infantil Montijo

Montijo (ESP), 18 Feb 2023

-63 kg

17 Judoka

POOL A

1	IPARRAGUIRRE BECERRA, Aitana	GAL	1	IPARRAGUIRRE BECERRA, A. (GAL)
17			17	
9	GONZALEZ LORIENTE, Martina	ARA	2	GONZALEZ LORIENTE, M. (ARA)
25			25	
5	LABARGA GONZALEZ, Celia	CLE	3	LABARGA GONZALEZ, C. (CLE)
21			18	
13			4	FONTAN ALVAREZ, N. (EXT)
29	FONTAN ALVAREZ, Nerea	EXT	4	FONTAN ALVAREZ, N. (EXT)

POOL A Winner / Ganador
Vainqueur / Sieger

POOL B

3	MBENGUE RUANO, Deguene Aisha	CAN	5	MBENGUE RUANO, D. (CAN)
19			19	
11			6	ROMERO GOMES, A. (EXT)
27	ROMERO GOMES, Alicia Gabrielle	EXT	6	ROMERO GOMES, A. (EXT)
7	SOUZA VAZQUEZ, Antonella	GAL	7	SOUZA VAZQUEZ, A. (GAL)
23			20	
15	SANTANA, Matilde	POR	8	SANTANA, Matilde (POR)
31			8	SANTANA, Matilde (POR)

POOL B Winner / Ganador
Vainqueur / Sieger

POOL C

2	RUIZ VELASCO, Belen	MAD	9	RUIZ VELASCO, B. (MAD)
18			21	
10	CRUZ SAEZ, Daniela	EXT	10	CRUZ SAEZ, D. (EXT)
26			21	
6	ORTIZ MURCIA, Silvia	MUR	11	ORTIZ MURCIA, S. (MUR)
22			22	
14	COSTA, Isabel	POR	12	COSTA, Isabel (POR)
30			22	

POOL C Winner / Ganador
Vainqueur / Sieger

POOL D

4	VERA SANTOS, Jessica Del Valle	CAN	13	VERA SANTOS, J. (CAN)
20			23	
12			14	LEITAO, M. (POR)
28	LEITAO, Madalena	POR	14	LEITAO, M. (POR)
8	RIERA GARCIA, Nora	MAD	15	RIERA GARCIA, N. (MAD)
24			24	
16	PADILLA VICENTE, Selena	ARA	16	
32	REDONDO GALLEGO, Laura	EXT	16	

POOL D Winner / Ganador
Vainqueur / Sieger

1.

43

Results

Résultat / Platzierungen / Resultados

- 1.
- 2.
- 3.
- 3.
- 5.
- 5.
- 7.
- 7.

Trostrunde / Repechage / Ronda de consolación

Repechage / Trostrunde / Repechage

[A1]		29		33		
[A2]			[A3]			
[B1]		30		34		39
[B2]			[B3]			
[C1]		31		35		[38]
[C2]			[C3]			
[D1]		32		36		40
[D2]			[D3]			
						[37]

3.

3.

Supercopa de España Infantil Montijo

Montijo (ESP), 18 Feb 2023

+63 kg

8 Judoka

