



Copa de Espana Cadete Extremadura 2022

Don Benito (EXT), 14 May 2022

-50 kg

24 Judoka

POOL A

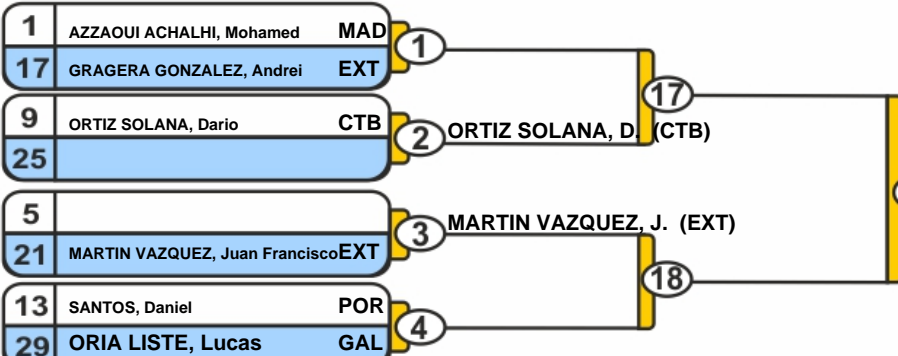

POOL A Winner / Ganador
Vainqueur / Sieger

POOL B

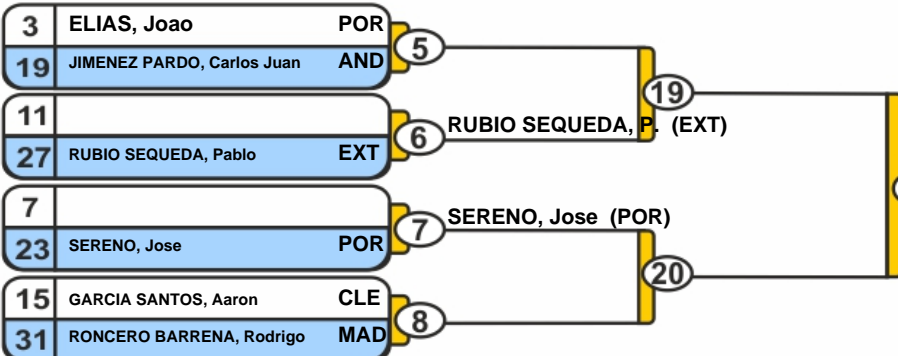

POOL B Winner / Ganador
Vainqueur / Sieger

POOL C

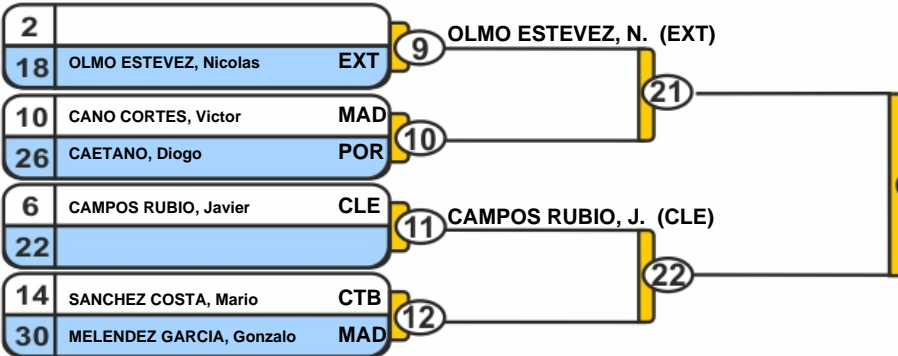

POOL C Winner / Ganador
Vainqueur / Sieger

POOL D

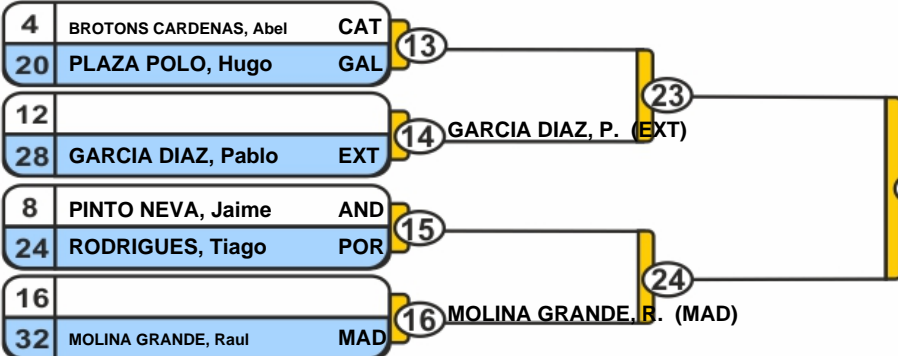

POOL D Winner / Ganador
Vainqueur / Sieger

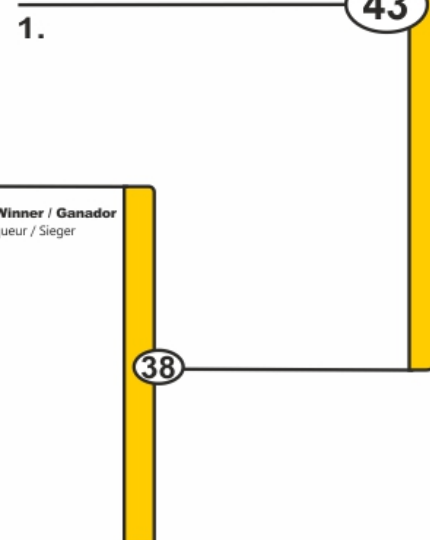

Repechage / Trostrunde / Repechage

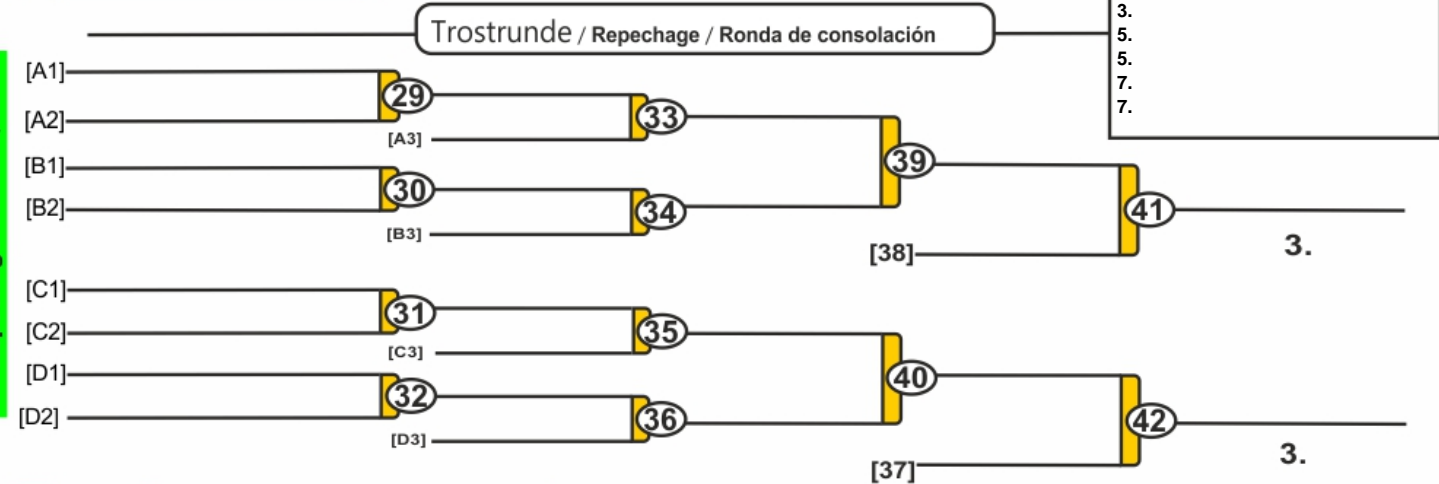

Results	
Résultat / Platzierungen / Resultados	
1.	
2.	
3.	
3.	
5.	
5.	
7.	
7.	



Copa de Espana Cadete Extremadura 2022

Don Benito (EXT), 14 May 2022

-55 kg

29 Judoka

POOL A

1	PACHECO HERNANDEZ-MONTANO, Javier	EXT	1
17	ALVAREZ SHUTOV, Daniel	AND	17
9			2
25	DAVYDIAN, Ernest	VAL	25
5	PAJARES DOMINGUEZ, Jose	MAD	3
21	TORRES CAPARROS, Dario	AND	18
13	KVANTIDZE, Nika	POR	4
29	LAFUENTE FERNANDEZ, Diego	GAL	19

POOL A Winner / Ganador
Vainqueur / Sieger

POOL B

3	SALA BERRUECO, Miguel Angel	VAL	5
19	RUIZ SANTOS, Jose Maria	AND	19
11	MUNOZ MORENO, Unai	MEL	6
27	ESTEBAN COELLO, Hugo	MAD	7
7			7
23	GARCIA GOMEZ, Victor Manuel	AND	20
15	SOUSA, Antonio	POR	8
31	LESTON GARCIA, Ricardo	GAL	21

POOL B Winner / Ganador
Vainqueur / Sieger

POOL C

2	GARCIA ZAMORA, Ivo	VAL	9
18	ROJAS BENITEZ, Guillermo	MAD	21
10	ROSADO LOPEZ, Rodrigo	AND	10
26	FERNANDEZ DE LA IGLESIA, David	GAL	22
6	SILVA, Manuel	POR	11
22	ALCAZAR CRESPO, Manuel	EXT	22
14	MOLINA VILCHEZ, Raul	AND	12
30			12

POOL C Winner / Ganador
Vainqueur / Sieger

POOL D

4	MANSO FERNANDEZ, Oscar	MAD	13
20	DE MARIA ALMORZA, Adan	AND	23
12	GALLARDO CRUZ, Marcos	AND	14
28	VAZ, Pedro	POR	24
8	FERNANDEZ FERNANDEZ, Iker	GAL	15
24	SANCHEZ GARCIA, Ivan	AND	24
16	VAZQUEZ SALAZAR, Felix	EXT	16
32	MARTIN GOMEZ, Pablo	CTB	16

POOL D Winner / Ganador
Vainqueur / Sieger

1.

43

37

38

28

Trostrunde / Repechage / Ronda de consolación

Repechage / Trostrunde / Repechage

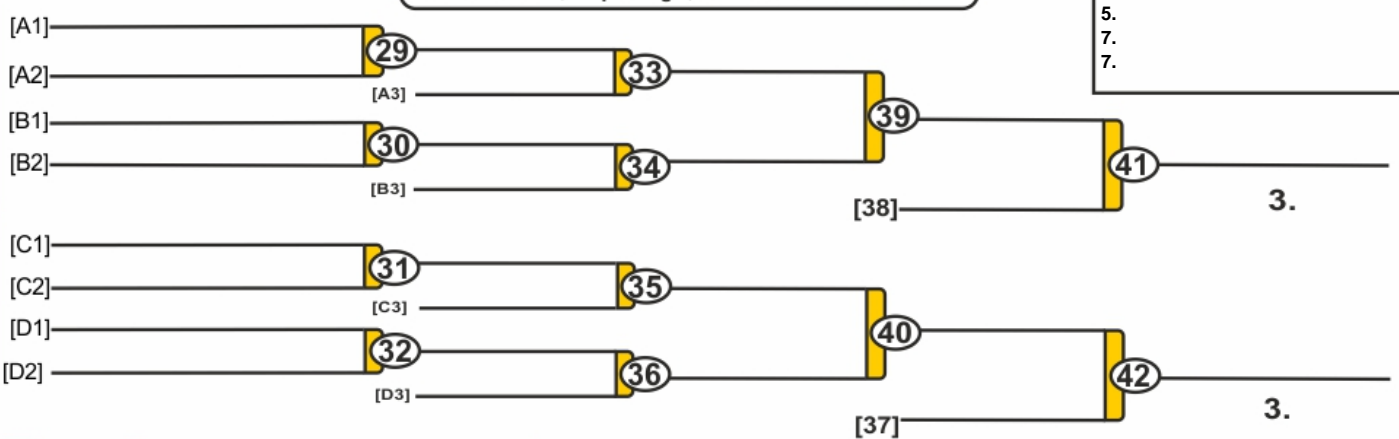

Results	
Résultat / Platzierungen / Resultados	
1.	
2.	
3.	
4.	
5.	
6.	
7.	



Copa de Espana Cadete Extremadura 2022

Don Benito (EXT), 14 May 2022

-60 kg
47 Judoka

POOL A

1	GATA, Mateus	POR
33	LANZAT ALBALALEJO, Ignacio	MAD
17	DE PEDRO CUADRADO, Mario	GLE
49		
9		
41	ABELLAN ARJONES, Marcos	MAD
25	GAMEZ, Antonio	AND
57	CUBREIRO MORENO, Manuel	GAL
5	GARCIA RODRIGUEZ, Abel	GAL
37		
21	FRAILE RAMOS, Jesus	EXT
53	BEDOYA BUSTAMANTE, Manuel	MAD
13	TITOS ALARCON, Pablo	AND
45	PIZARRO CASAS, Ivan	MAD
29		
61	COSTA, Carlos	POR

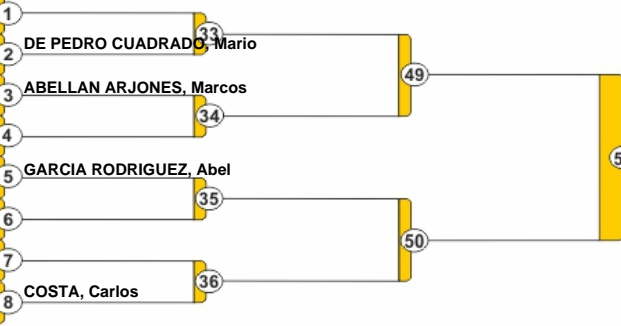

POOL A Winner / Ganador
Vainqueur / Sieger

POOL B

3		
35	RYBAKOV, Parfan	AND
19	GREGORIO, Carlos	POR
51	LOURO SANCHEZ, Matias	GAL
11	LYSOGOR CHERKESOV, Maxim	MAD
43		
27	GUZMAN COLAZO, Alejandro	EXT
59	MINAMBRES PARDO, Samuel	GAL
7		
39	ESPEJO SAAVEDRA VALDEARRAMA, Manuel	AND
23	CROZAT, Samuel	MAD
55	HOLTERMAN, Santiago	POR
15	UTRERO CRESPO, Iker	MAD
47	SIEIRO VAZQUEZ, Pablo	GAL
31		
63	ROMERO QUINTANA, Sergio	EXT

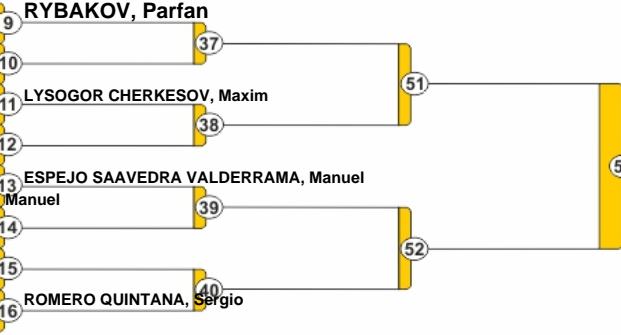

POOL B Winner / Ganador
Vainqueur / Sieger

POOL C

2		
34	LAGO GONZALEZ-SIERRA, Luis	GAL
18	PEREZ CAVERO, Adrian	MAD
50	RICO, Rafael	POR
10	MAZUELOS GOMEZ, Manuel	AND
42		
26	GARCIA GONZALEZ, Ivan	MAD
58	NAVARRETE GEA, Alejandro	VAL
6	SILVA, Cristian	POR
38	TATO FERNANDEZ, Samuel	GAL
22	SAYAGUES RODRIGUEZ, Marco	GLE
54		
14		
46	COELLO ALSHEVSKA, Leonardo	MAD
30		
62	VILLALOBOS PEREZ, Pablo	EXT

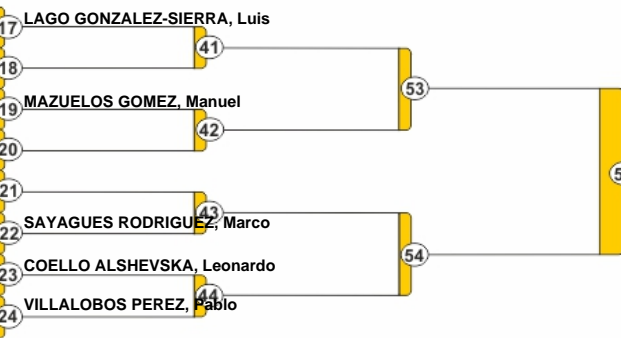

POOL C Winner / Ganador
Vainqueur / Sieger

POOL D

4	TORREGROSA IGLESIA, Rau	AND
36	FLORES RIPALDA, Jose Antonio	MAD
20		
52	ALAYO MANZANO, Jose Andres	GLE
12	TALAVERA GONZALEZ, Jesus	EXT
44	CASTEDO TRASHORRAS, Carlos	GAL
28		
60	REIS, Rafael	POR
8	REIS, Joao	POR
40	SALGADO ROS, Diego	MAD
24		
56	GARCIA RODRIGUEZ, Hugo	CTB
16		
48	SOUSA LAVANDEIRA, Breixo	GAL
32	BAUTISTA SUAREZ, Ruben	AND
64	DE LA FUENTE REPILADO, Alberto	MAD

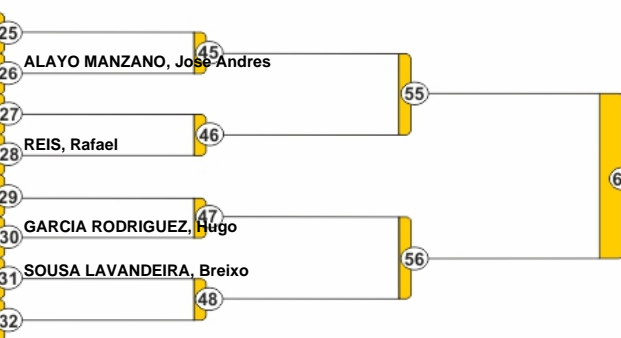

POOL D Winner / Ganador
Vainqueur / Sieger

1.

79

73

58

74

Results

Résultat / Platzierungen / Resultados

- 1.
- 2.
- 3.
- 5.
- 5.
- 7.
- 7.

Trostrunde / Repechage / Ronda de consolación

Repechage / Trostrunde / Repechage

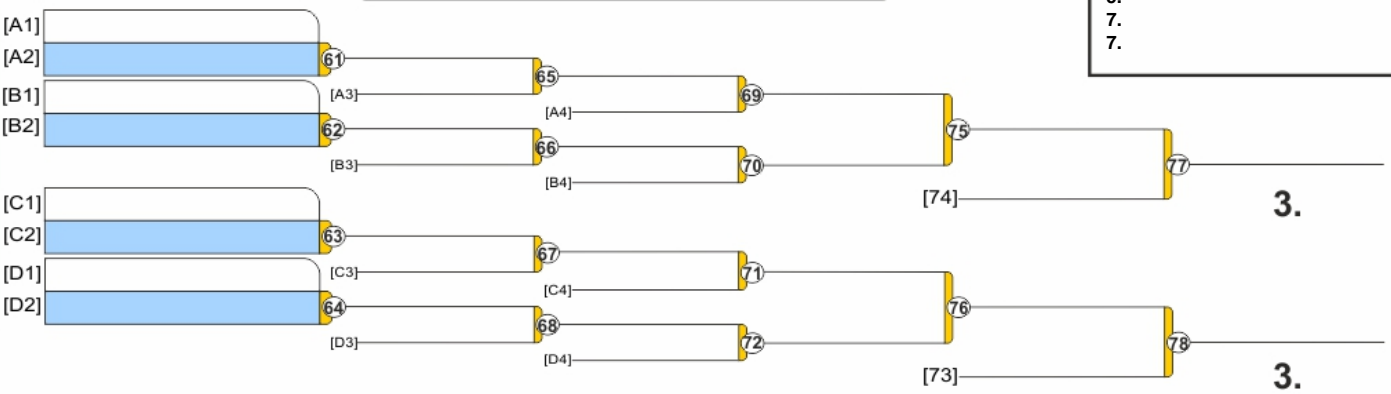

3.

3.



Copa de Espana Cadete Extremadura 2022

Don Benito (EXT), 14 May 2022

-66 kg
36 Judoka

POOL A

1	LOMENA MOLINA, Hugo	MEL
33	TREJO QUINTANA, Marcos	EXT
17	VALLEJO NESTAR, Hugo	AND
49	VALLEJO NESTAR, Hugo	AND
9	PAREDES DIETZ, Lucas	MAD
41	PAREDES DIETZ, Lucas	MAD
25	PEREIRA, Henrique	POR
57	MATEOS SANCHEZ, Alonso	MAD
37	MATEOS SANCHEZ, Alonso	MAD
21	CERRO CASTILLO, Aitor	EXT
53	SUKACH, Mihail	VAL
13	SUKACH, Mihail	VAL
45	ROCHA MIRANDA, Mateo	GAL
29	ROCHA MIRANDA, Mateo	GAL
61		



POOL A Winner / Ganador
Vainqueur / Sieger

POOL B

3	ALMODOVAR, Francisco	POR
35	ALMODOVAR, Francisco	POR
19	ALBARRAN PRISACARIU, Sergio	MAD
51	ALBARRAN PRISACARIU, Sergio	MAD
11	BLANCO MARIA, Jesus	GAL
43	BLANCO MARIA, Jesus	GAL
27	CARRASCO CAMPOS, Dario	AND
59	VALDES ALONSO, Victor Alejandro	ARA
7	MARI ALCUBIERRE, David	ARA
39	MARI ALCUBIERRE, David	ARA
23	HERNANDO FUSTER, Alejandro	MAD
55	HERNANDO FUSTER, Alejandro	MAD
15	TALON GUILLEM, Javier	VAL
47	TALON GUILLEM, Javier	VAL
31	PIZARRO CASAS, Carlos	MAD
63	PIZARRO CASAS, Carlos	MAD

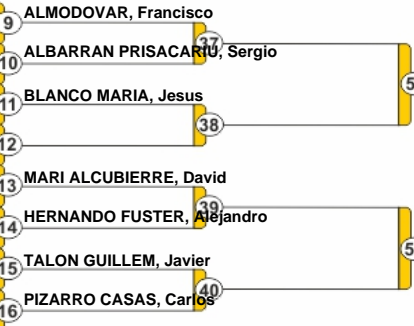

POOL B Winner / Ganador
Vainqueur / Sieger

POOL C

2	FERNANDEZ SAINZ, Raul	MAD
34	FERNANDEZ SAINZ, Raul	MAD
18	ROMERO GONZALO, Jose Luis	EXT
50	BAETZ, Henry	AND
10	VILA VILLARES, David	GAL
42	VILA VILLARES, David	GAL
26	ALVES, Francisco	POR
58	ALVES, Francisco	POR
6	DRZYZGA, Javier Rafael	MAD
38	DRZYZGA, Javier Rafael	MAD
22	GARCIA ESPANA, Jon	ARA
54	GARCIA ESPANA, Jon	ARA
14	MARTIN VELAZQUEZ, Javier	CLE
46	MARTIN VELAZQUEZ, Javier	CLE
30	RUIZ PEREZ, Diego	EXT
62	RUIZ PEREZ, Diego	EXT

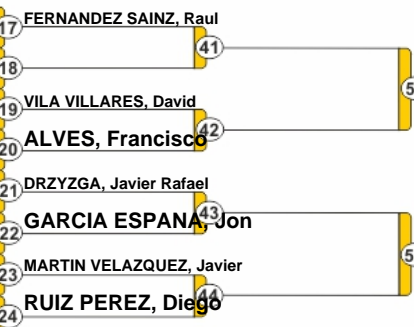

POOL C Winner / Ganador
Vainqueur / Sieger

POOL D

4	PINTO, Daniel	POR
36	PINTO, Daniel	POR
20	BLAZQUEZ SANZ, Victor	MAD
52	BLAZQUEZ SANZ, Victor	MAD
12	MORCATE REYES, Pedro	ARA
44	MORCATE REYES, Pedro	ARA
28	SOSA RICO, Alberto	EXT
60	SOSA RICO, Alberto	EXT
8	TOMAS QUIRANT, Roberto	VAL
40	TOMAS QUIRANT, Roberto	VAL
24	DE LA CRUZ PINEDA, Jaime	AND
56	DE LA CRUZ PINEDA, Jaime	AND
16	SOTODOSOS PEREZ, Sergio	CTB
48	SOTODOSOS PEREZ, Sergio	CTB
32	MANCERA DIAZ, Jose	EXT
64	MANCERA DIAZ, Jose	EXT
8	CABALLERO SANZ, Daniel	MAD
40	CABALLERO SANZ, Daniel	MAD



POOL D Winner / Ganador
Vainqueur / Sieger

1.

74

60

3.

3.

Trostrunde / Repechage / Ronda de consolación

Repechage / Trostrunde / Repechage

[A1]		
[A2]		
[B1]		
[B2]		
[C1]		
[C2]		
[D1]		
[D2]		

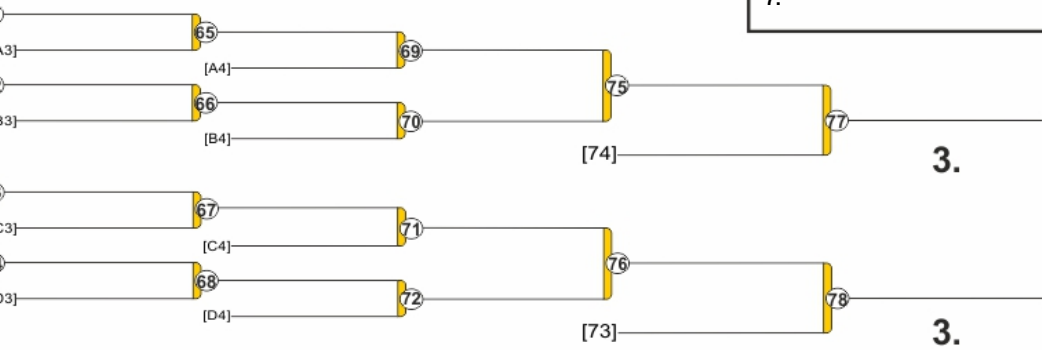

Results
Résultat / Platzierungen / Resultados

-
-
-
-
-
-
-



Copa de Espana Cadete Extremadura 2022

Don Benito (EXT), 14 May 2022

-73 kg

22 Judoka

POOL A

1	LOPEZ BACHILLER, Ignacio	MAD	1	LOPEZ BACHILLER, I. (MAD)
17			17	
9			2	RODRIGUEZ SANTIN, E. (GAL)
25	RODRIGUEZ SANTIN, Enrique	GAL	25	
5	VELASCO DIEZ, Ricardo	AND	3	
21	MAGALHAES, Tomas	POR	18	
13			4	ORTIZ RUEDA, D. (EXT)
29	ORTIZ RUEDA, David	EXT	29	

POOL A Winner / Ganador
Vainqueur / Sieger

POOL B

3			5	CUADRADO SEGURA, S. (MEL)
19	CUADRADO SEGURA, Sergio	MEL	19	
11	SUAREZ MEDINA, Bayron Andres	MAD	6	
27	PARDO VELASCO, Diego	CLE	20	
7	ORTIZ DURAN, Ibai	MAD	7	ORTIZ DURAN, I. (MAD)
23			20	
15	GARCIA MAYO, Roberto	GAL	8	
31	BENEDI DE ARCE, Javier	ARA	31	

POOL B Winner / Ganador
Vainqueur / Sieger

POOL C

2	IGLESIAS GARZON, Quintin	CLE	9	IGLESIAS GARZON, Q. (CLE)
18			21	
10	ARMENTEROS GRANJO, David	MAD	10	ARMENTEROS GRANJO, D. (MAD)
26			21	
6			11	SUAREZ IGLESIAS, N. (GAL)
22	SUAREZ IGLESIAS, Nicolas	GAL	22	
14	SANCHEZ VALLE, David	MAD	12	
30	STEFAN, Denis	AND	30	

POOL C Winner / Ganador
Vainqueur / Sieger

POOL D

4	COCA ANTON, Iker	CLE	13	COCA ANTON, Iker (CLE)
20			23	
12	AGUILERA BAUTISTA, Alberto	EXT	14	
28	SANCHEZ CUESTA, Daniel	MAD	23	
8	CERQUEIRA SANCHEZ, Alejandro	AND	15	CERQUEIRA SANCHEZ, A. (AND)
24			24	
16	LEBID, Dmytro	POR	16	
32	LOZANO-GOTOR GOMEZ, Francisc	MAD	32	

POOL D Winner / Ganador
Vainqueur / Sieger

Repechage / Trostrunde / Repechage

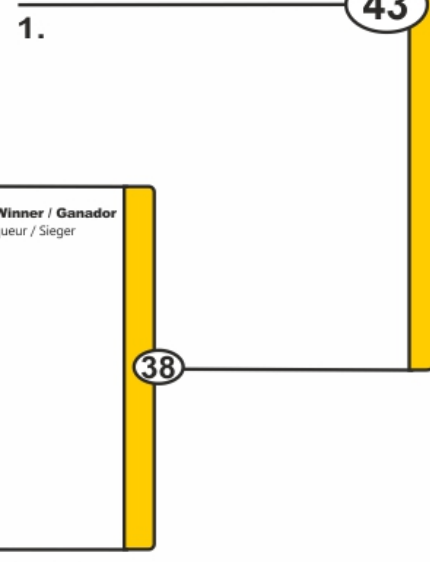
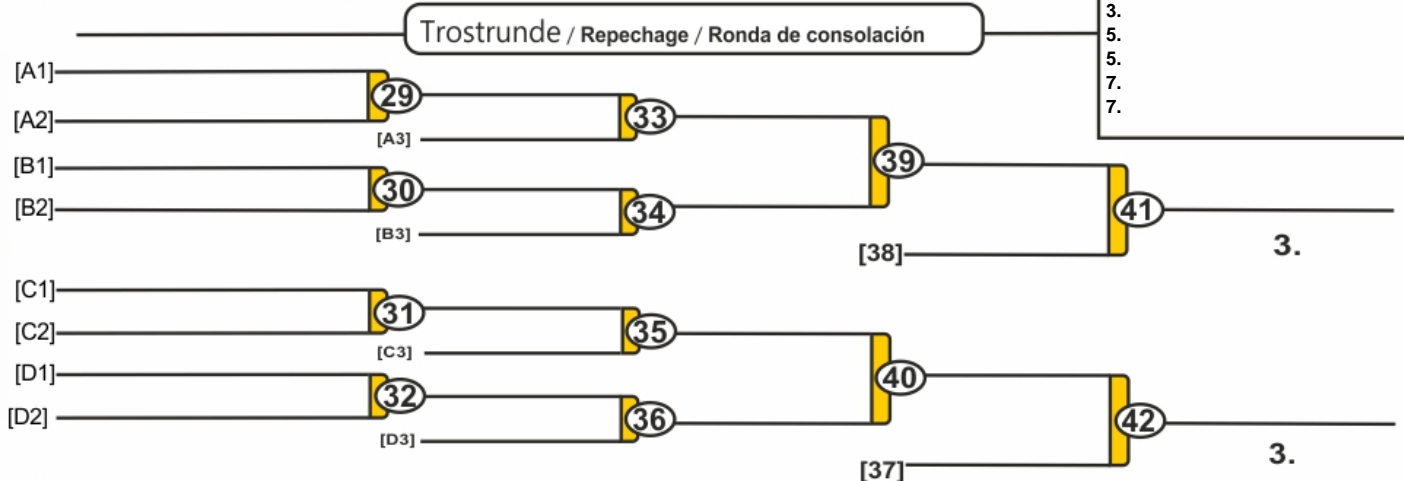

Results	
Résultat / Platzierungen / Resultados	
1.	
2.	
3.	
3.	
5.	
5.	
7.	
7.	



Copa de Espana Cadete Extremadura 2022

Don Benito (EXT), 14 May 2022

-81 kg

12 Judoka

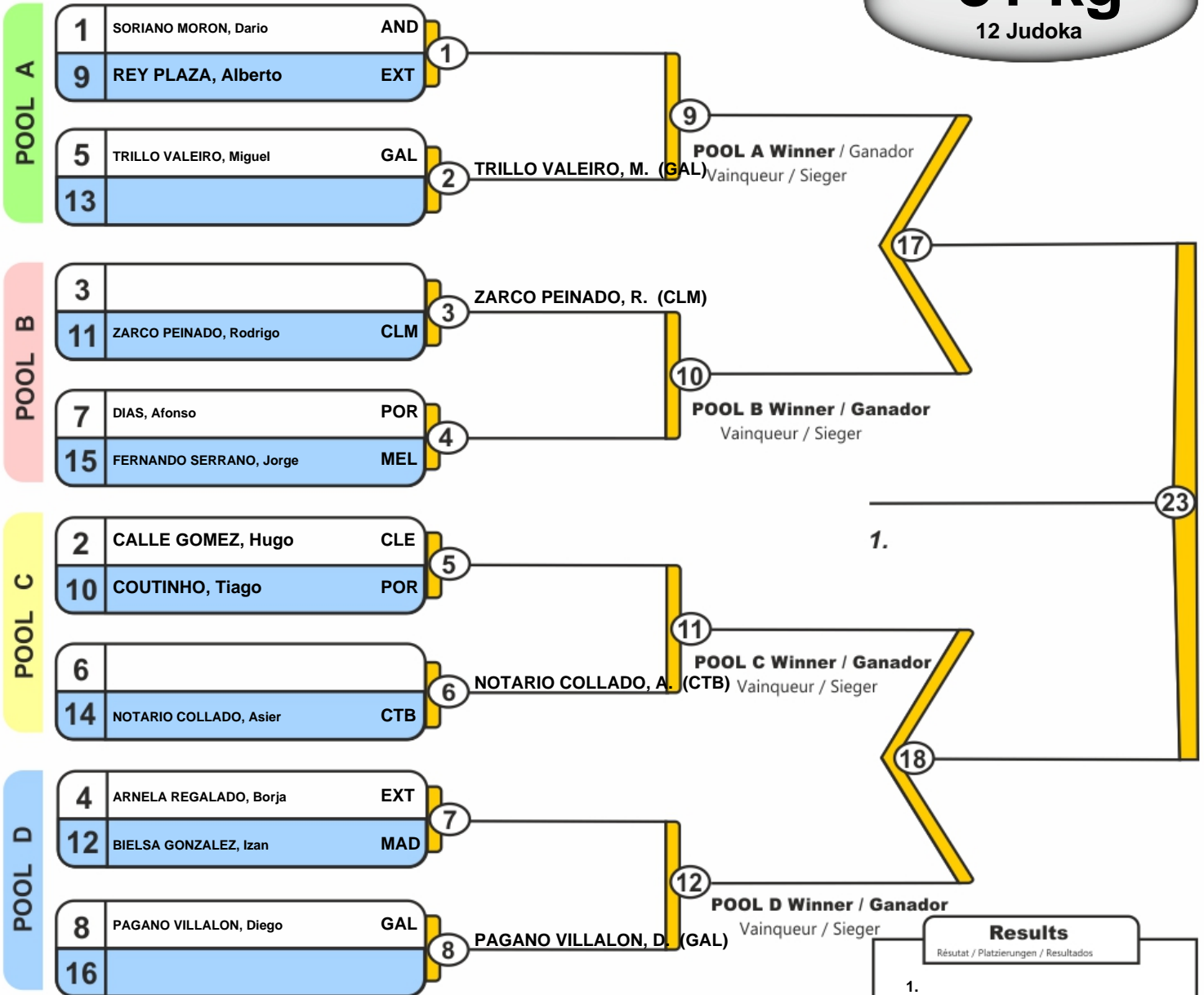

Trostrunde / Repechage / Ronda de consolación

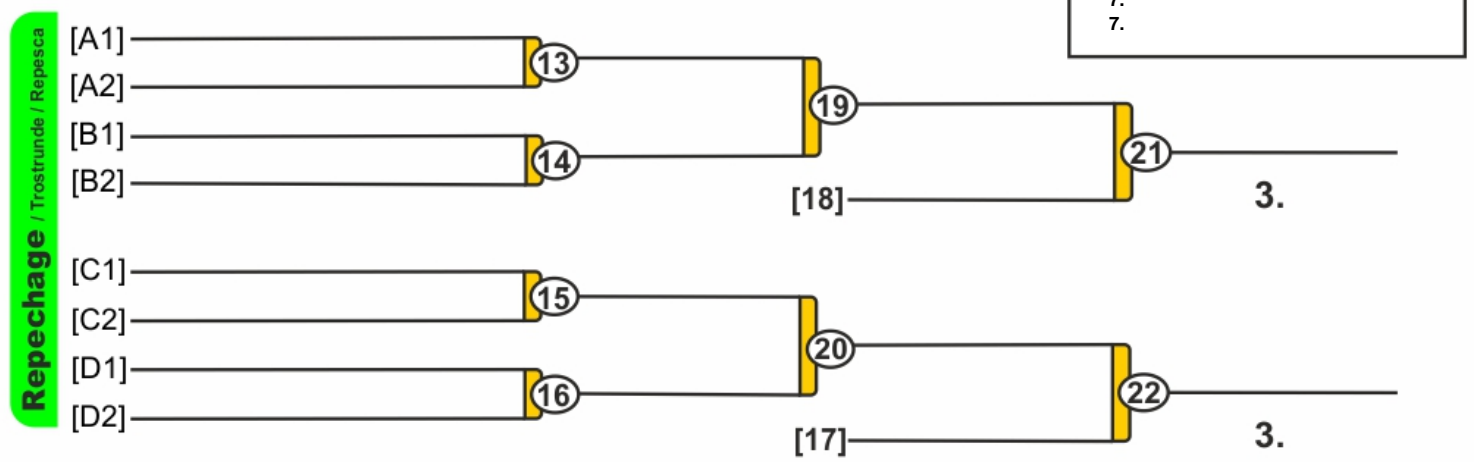

Results	
Résultat / Platzierungen / Resultados	
1.	
2.	
3.	
3.	
5.	
7.	
7.	





Copa de Espana Cadete Extremadura 2022

Don Benito (EXT), 14 May 2022

-90 kg

5 Judoka

		1	2	3	4	5	
1	ROMERO NAKHIL, Carlos Karim	AND					(0)
2	BELMONTE DIAZ, Jose Francisco	AND					(0)
3	RODRIGUEZ MONTERO, Roberto	AND					(0)
4	NEBLEA, Marian Alexandru	GAL					(0)
5	COELLO LOPEZ, Diego	MAD					(0)

1	ROMERO NAKHIL, Carlos Karim	AND	1
2	BELMONTE DIAZ, Jose Francisco	AND	

3	RODRIGUEZ MONTERO, Roberto	AND	2
4	NEBLEA, Marian Alexandru	GAL	

1	ROMERO NAKHIL, Carlos Karim	AND	3
5	COELLO LOPEZ, Diego	MAD	

2	BELMONTE DIAZ, Jose Francisco	AND	4
3	RODRIGUEZ MONTERO, Roberto	AND	

4	NEBLEA, Marian Alexandru	GAL	5
5	COELLO LOPEZ, Diego	MAD	

1	ROMERO NAKHIL, Carlos Karim	AND	6
3	RODRIGUEZ MONTERO, Roberto	AND	

2	BELMONTE DIAZ, Jose Francisco	AND	7
4	NEBLEA, Marian Alexandru	GAL	

3	RODRIGUEZ MONTERO, Roberto	AND	8
5	COELLO LOPEZ, Diego	MAD	

1	ROMERO NAKHIL, Carlos Karim	AND	9
4	NEBLEA, Marian Alexandru	GAL	

2	BELMONTE DIAZ, Jose Francisco	AND	10
5	COELLO LOPEZ, Diego	MAD	

Final Results

- 1.
- 2.
- 3.





Copa de Espana Cadete Extremadura 2022

Don Benito (EXT), 14 May 2022

+90 kg

2 Judoka

Best of Three

1	FERNANDEZ LADERA, Juan Manu	EXT	1
2	RUIZ DIAZ, Juan Jose	AND	

1	FERNANDEZ LADERA, Juan Manu	EXT	2
2	RUIZ DIAZ, Juan Jose	AND	

1	FERNANDEZ LADERA, Juan Manu	EXT	3
2	RUIZ DIAZ, Juan Jose	AND	



14 de mayo de 2022
DON BENITO
CIUDAD DEPORTIVA

JUNTA DE EXTREMADURA



IBERDROLA



Final Results

- 1.
- 2.



Copa de Espana Cadete Extremadura 2022

Don Benito (EXT), 14 May 2022

-44 kg

6 Judoka

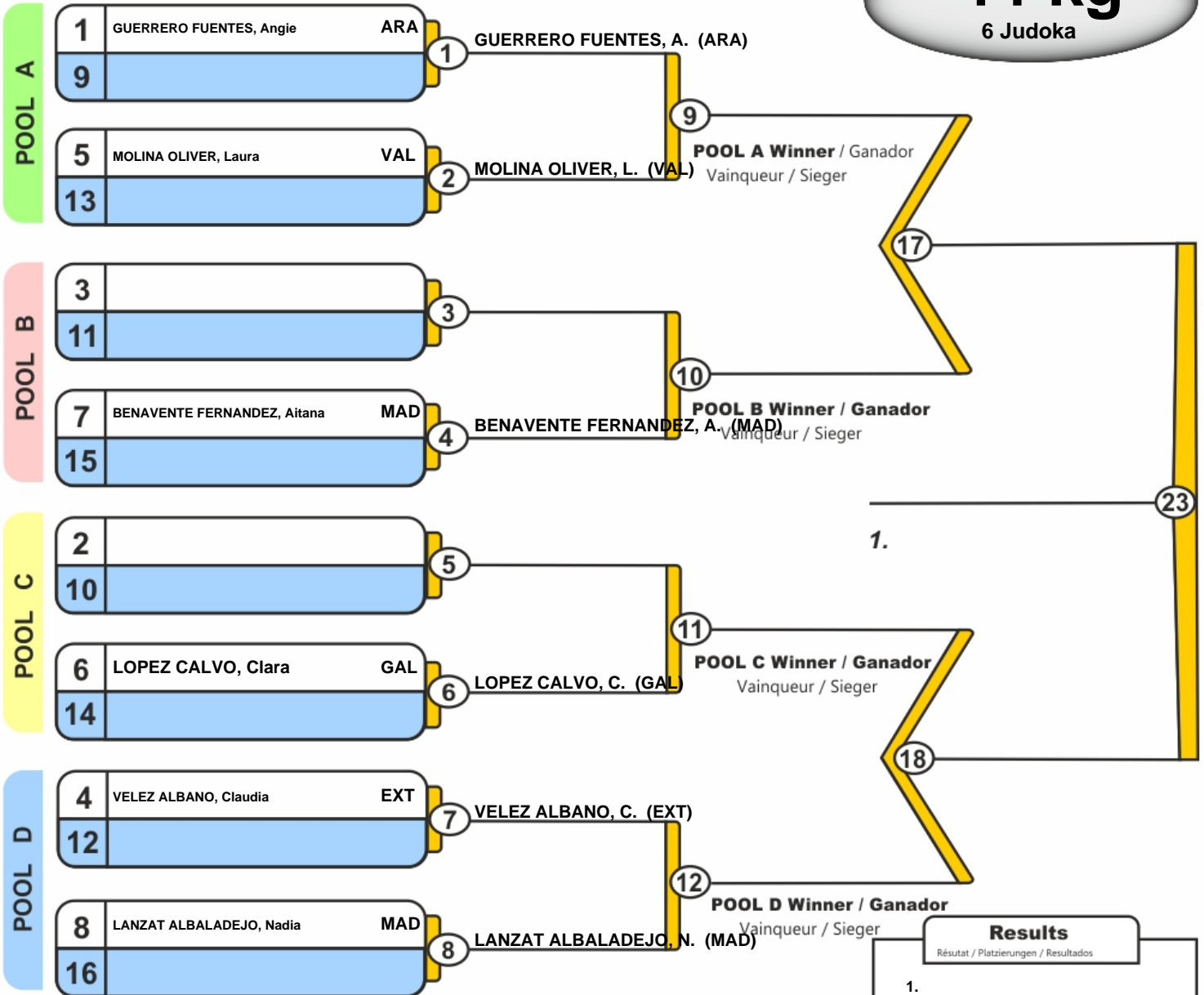

Trostrunde / Repechage / Ronda de consolación

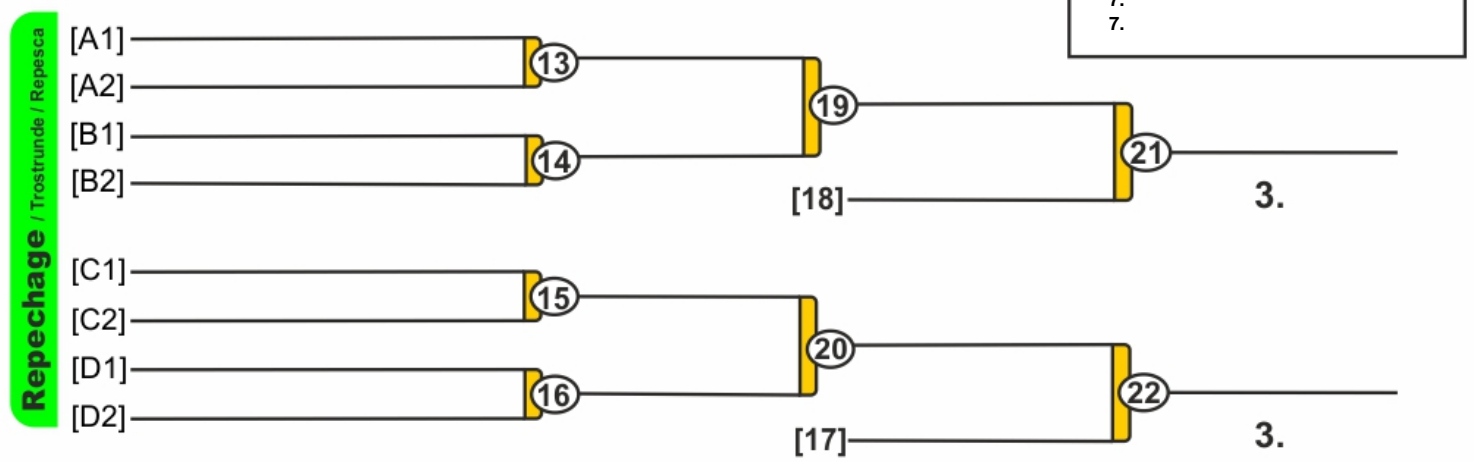

Results	
Résultat / Platzierungen / Resultados	
1.	
2.	
3.	
3.	
5.	
7.	
7.	



Copa de Espana Cadete Extremadura 2022

Don Benito (EXT), 14 May 2022

-48 kg

10 Judoka

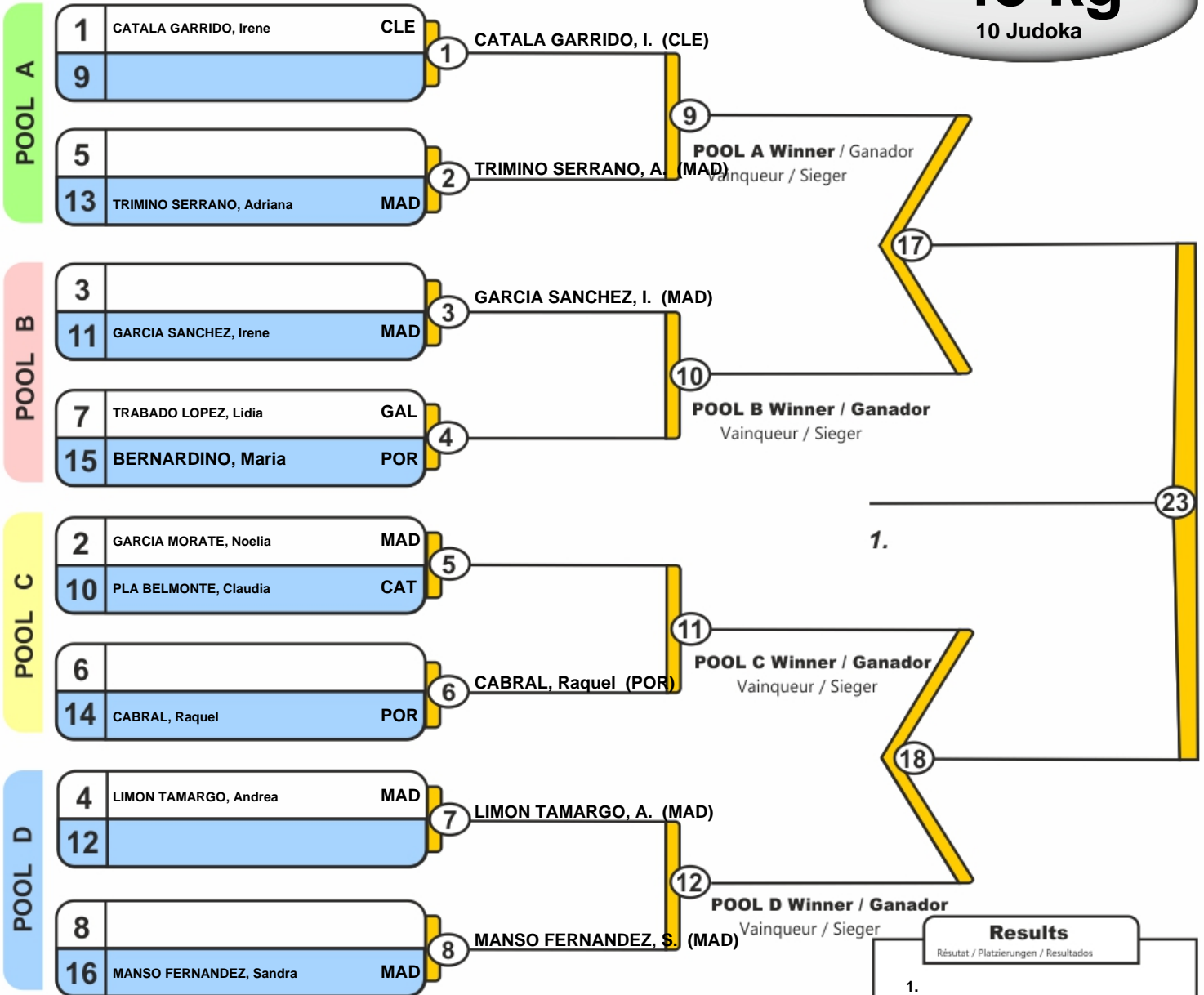

Trostrunde / Repechage / Ronda de consolación

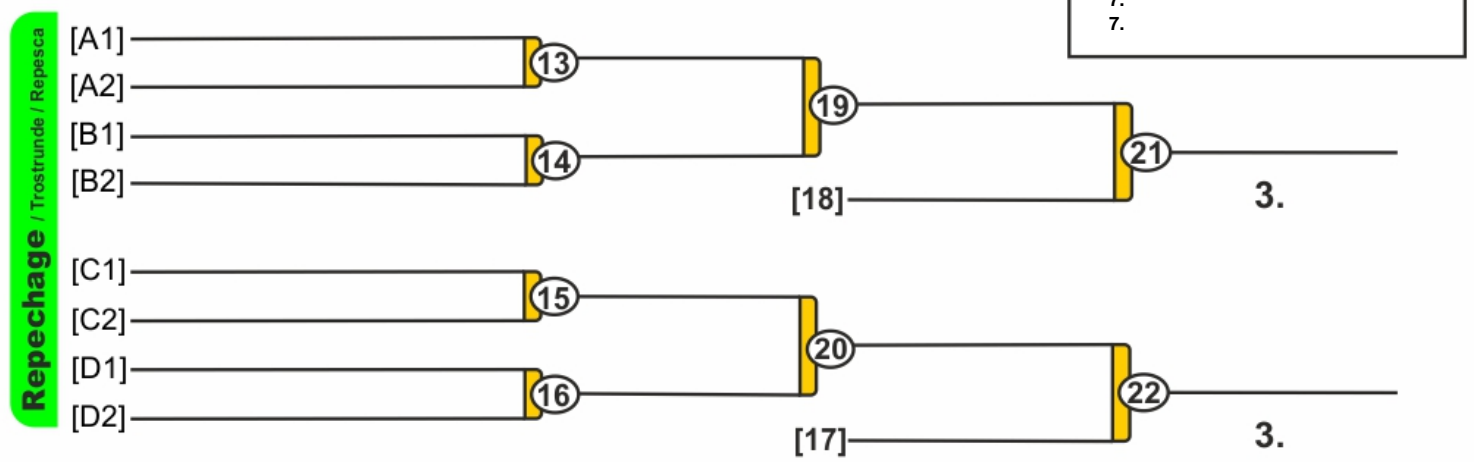

Results	
Résultat / Platzierungen / Resultados	
1.	
2.	
3.	
3.	
5.	
7.	
7.	





Copa de España Cadete Extremadura 2022

Don Benito (EXT), 14 May 2022

-52 kg

24 Judoka

POOL A

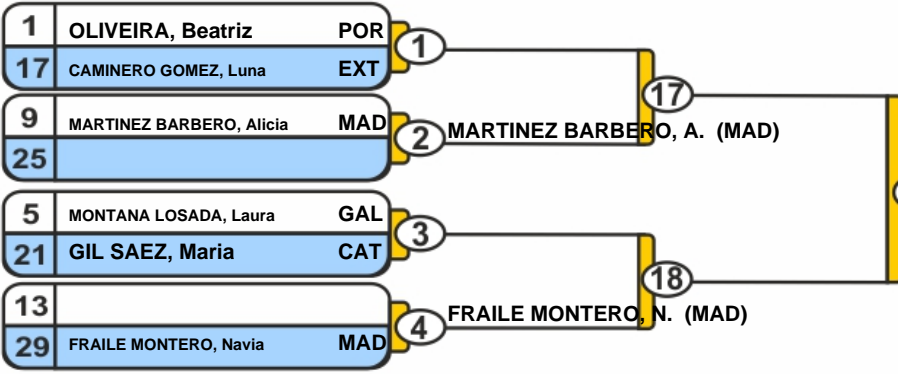

POOL A Winner / Ganador
Vainqueur / Sieger

POOL B

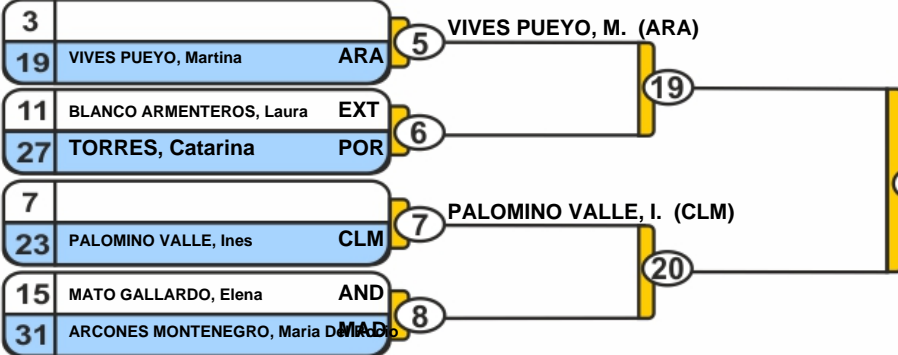

POOL B Winner / Ganador
Vainqueur / Sieger

POOL C

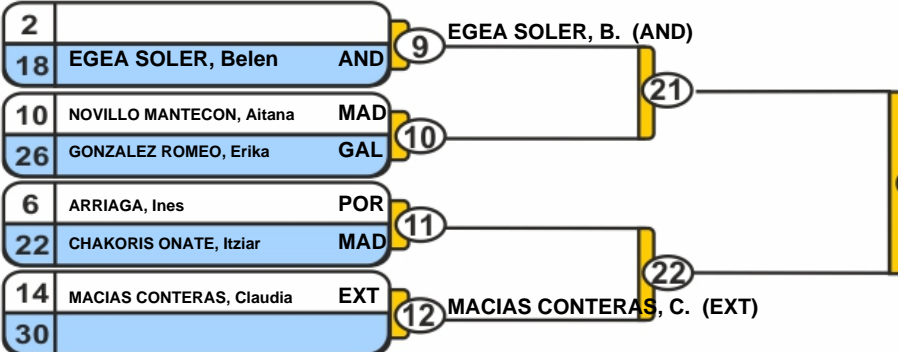

POOL C Winner / Ganador
Vainqueur / Sieger

POOL D

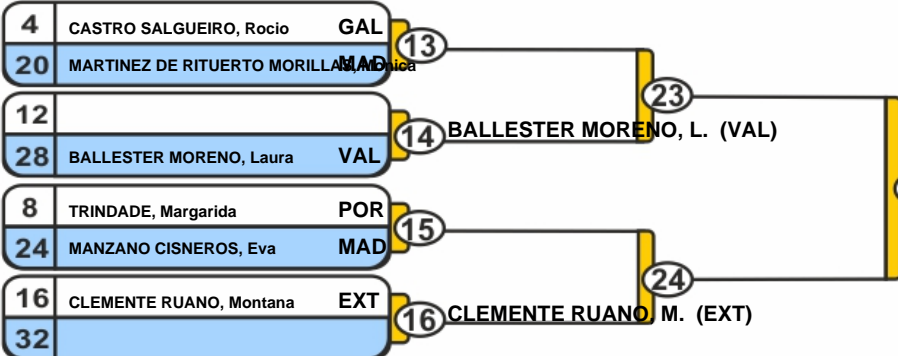

POOL D Winner / Ganador
Vainqueur / Sieger

1.

43

Results	
Résultat / Platzierungen / Resultados	
1.	
2.	
3.	
4.	
5.	
6.	
7.	

Trostrunde / Repechage / Ronda de consolación

Repechage / Trostrunde / Repechage

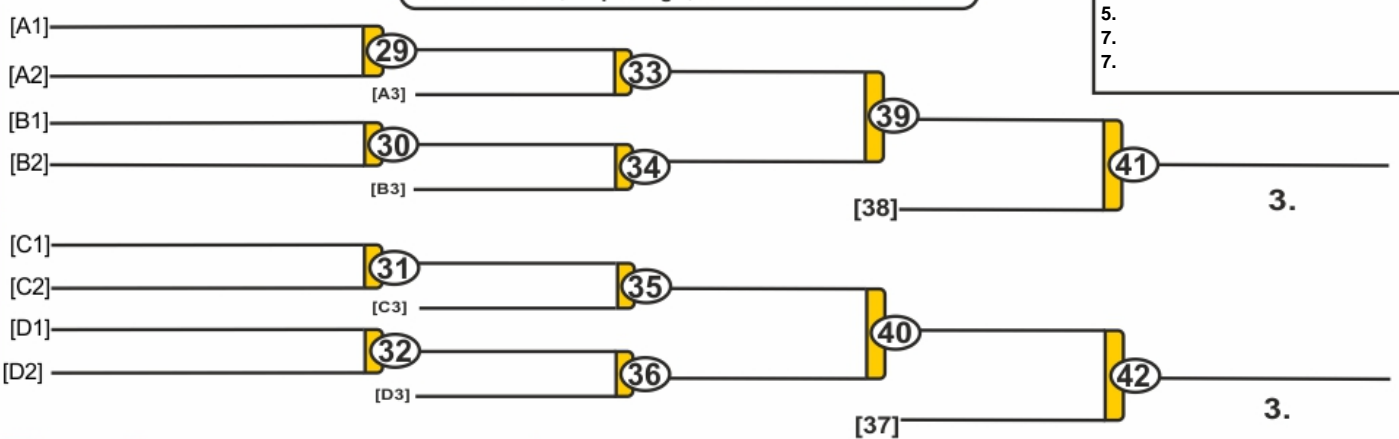

3.

3.



Copa de Espana Cadete Extremadura 2022

Don Benito (EXT), 14 May 2022

-57 kg
12 Judoka

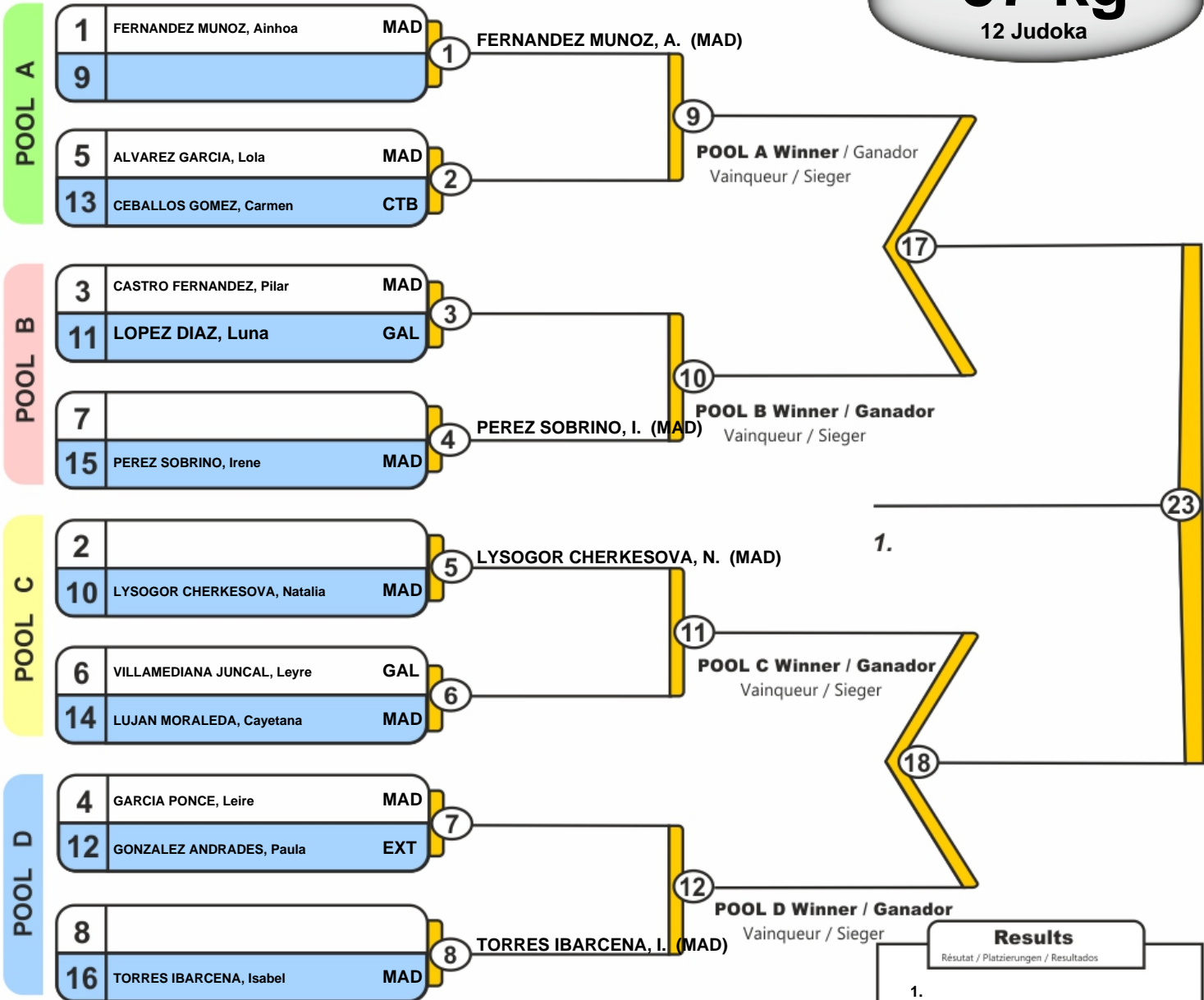

Trostrunde / Repechage / Ronda de consolación

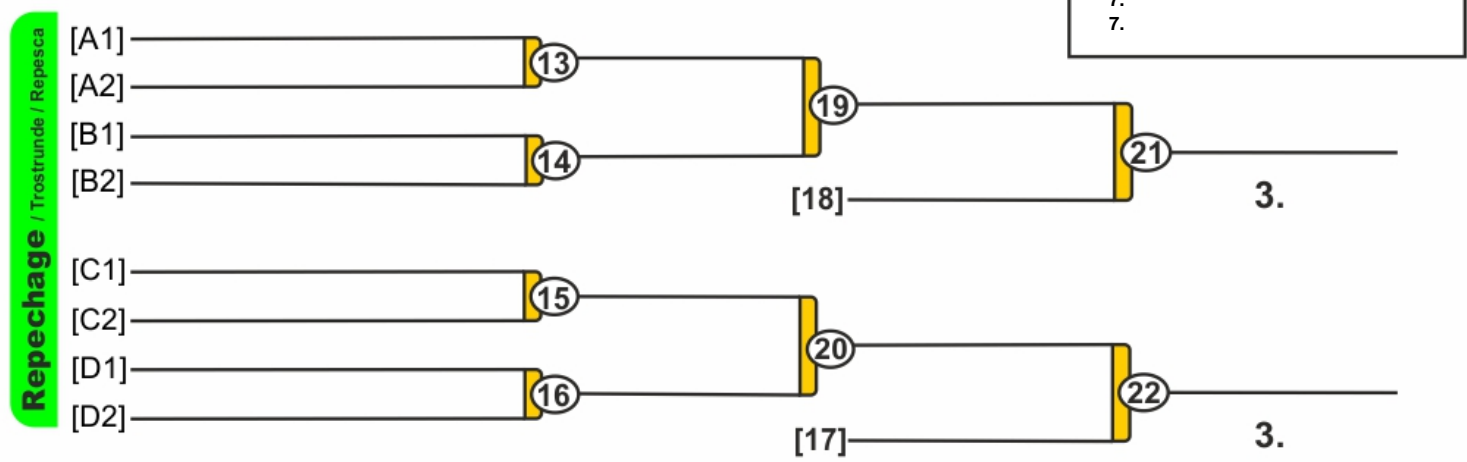

Results	
Résultat / Platzierungen / Resultados	
1.	
2.	
3.	
3.	
5.	
7.	
7.	



Copa de Espana Cadete Extremadura 2022

Don Benito (EXT), 14 May 2022

-63 kg
12 Judoka

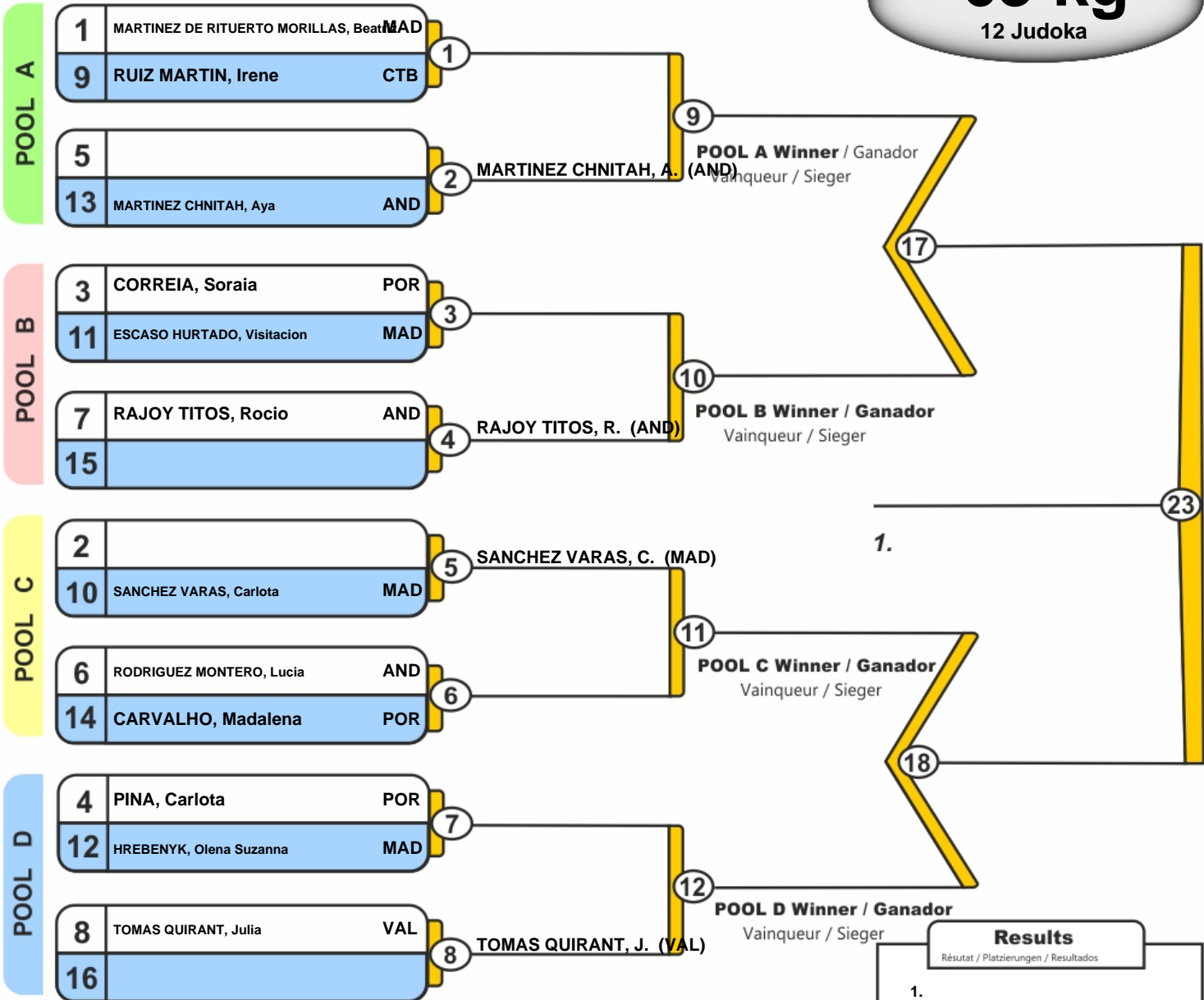

Trostrunde / Repechage / Ronda de consolación

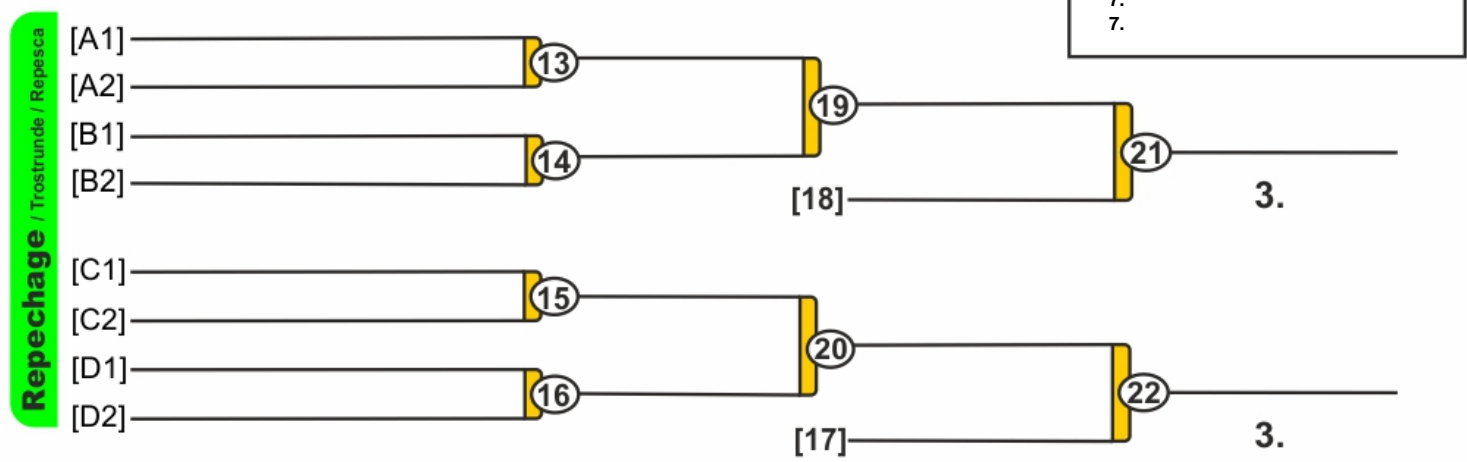

Results	
Résultat / Platzierungen / Resultados	
1.	
2.	
3.	
3.	
5.	
7.	
7.	





Copa de Espana Cadete Extremadura 2022

Don Benito (EXT), 14 May 2022

-70 kg

6 Judoka

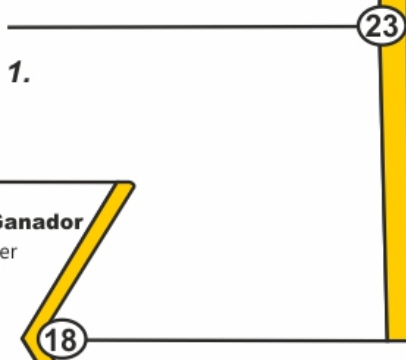
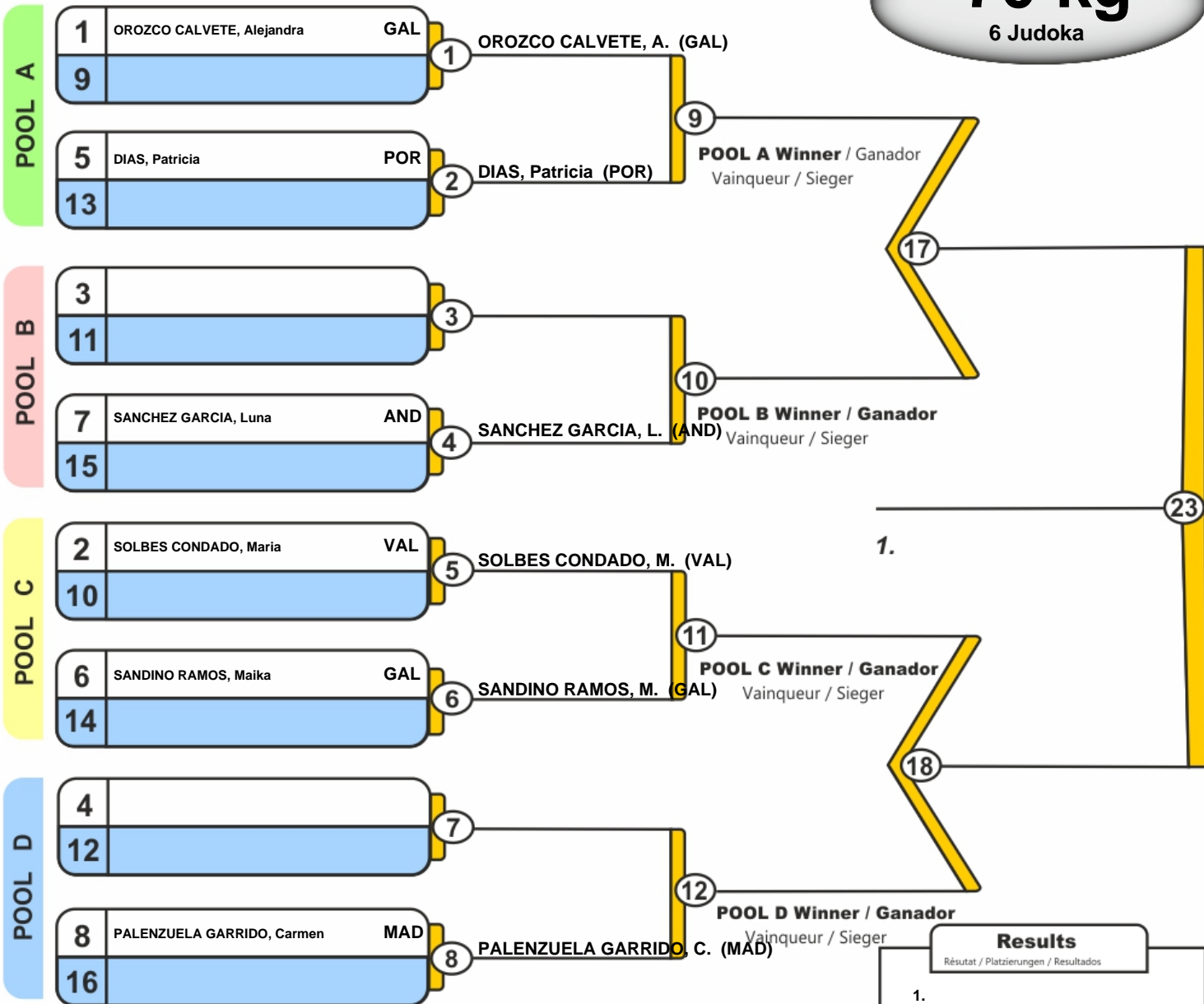

Trostrunde / Repechage / Ronda de consolación

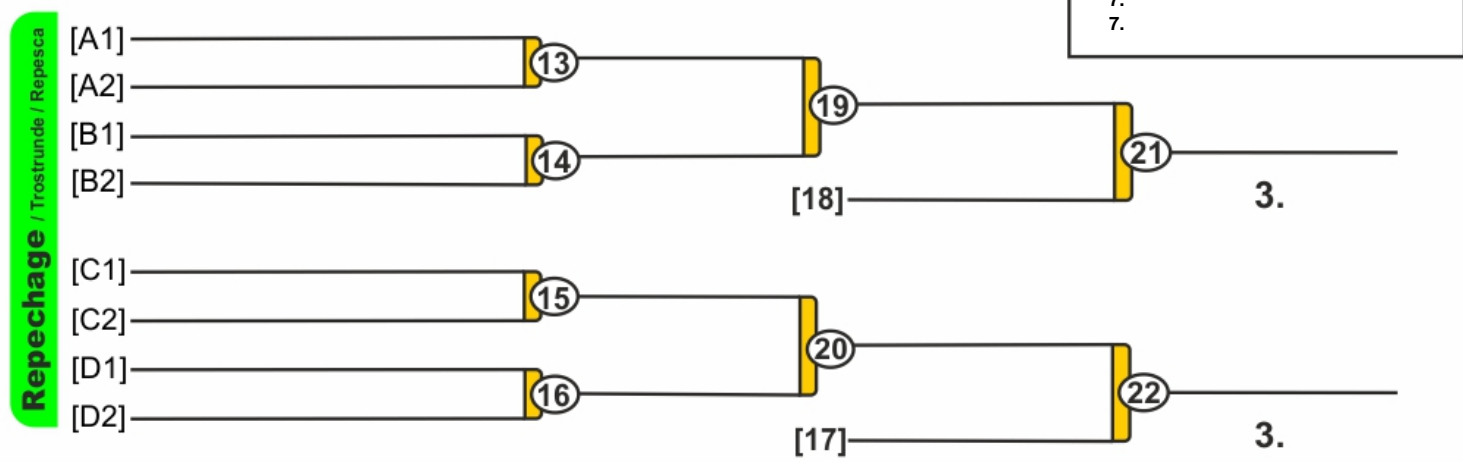

Results	
Résultat / Platzierungen / Resultados	
1.	
2.	
3.	
3.	
5.	
7.	
7.	



			1	2	3	4	
1	MARIN, Alejandra Beatriz	AND					0 (0)
2	PEREZ LOPEZ, Elia	AND					0 (0)
3	SANCHEZ VALLE, Andrea	MAD					0 (0)
4	VENTURA GONZALEZ, India	EXT					0 (0)

1	MARIN, Alejandra Beatriz	AND	1
2	PEREZ LOPEZ, Elia	AND	

3	SANCHEZ VALLE, Andrea	MAD	2
4	VENTURA GONZALEZ, India	EXT	

1	MARIN, Alejandra Beatriz	AND	3
3	SANCHEZ VALLE, Andrea	MAD	

2	PEREZ LOPEZ, Elia	AND	4
4	VENTURA GONZALEZ, India	EXT	

1	MARIN, Alejandra Beatriz	AND	5
4	VENTURA GONZALEZ, India	EXT	

2	PEREZ LOPEZ, Elia	AND	6
3	SANCHEZ VALLE, Andrea	MAD	



14 de mayo de 2022
DON BENITO
CIUDAD DEPORTIVA

JUNTA DE EXTREMADURA



IBERDROLA



Final Results

- 1.
- 2.
- 3.